

**NAKITA**

Born in the Austrian Alps. 2015

[www.nakita.at](http://www.nakita.at)





# NAKITA

Unsere Leidenschaft und Inspiration für das Bike steckt in jedem unserer Produkte. Die Ansprüche und Bedürfnisse unserer Kunden sind die Inspiration für unser hochqualifiziertes und technikbegeistertes Entwicklungsteam. Wertvolles Know-how unserer Mitarbeiter und die Erfahrungen unserer Teamfahrer hilft uns die besten und effektivsten Bikes zu produzieren.

Das Ergebnis sind perfekte Bikes von höchster Qualität.

Born in the Austrian Alps.

# TECHNOLOGIES



## CARBON MONOCOQUE

Carbonrahmen aus hochwertigen Carbonfasern hergestellt in Monocoque Bauweise für eine optimale Ausgewogenheit aus Steifigkeit, leichtem Gewicht und Flexibilität des Rahmens



## 3X BUTTED ALU-TECH

Rahmen aus hochlegiertem Aluminium, die dreifach konifzierten Rahmenrohre erzielen höchste Steifigkeit bei minimalem Gewicht. Die „smooth welding“ Technologie sorgt für hochfeste Schweissnähte und eine perfekte Optik



## 2X BUTTED ALU-TECH

Rahmen aus hochwertigem 6061 Aluminium, die zweifach konifzierten Rahmenrohre erzielen hohe Steifigkeit bei geringem Gewicht



## ALU-TECH

Rahmen aus hochwertigem 6061 Aluminium, für optimale Festigkeit und hochwertiger Optik angelehnt an unsere Spitzenmodelle



## SUPERLIGHT

Begriff für unsere Alurahmen der Spitzenklasse welche den Top-Anforderungen in Hinblick auf Gewicht und Steifigkeit entsprechen.



## INTERNAL CABLE ROUTING SYSTEM

Internal Cable Routing System - durchgehende Bowden sorgen für einen optimalen Gangwechsel und einer aufgeräumten Optik



## CARBON DROPOUT

Im Rahmen integriertes Carbon Ausfallende

## HMC HIGH MODULUS CARBON

Hochfeste Carbonfaser für höchste Steifigkeitswerte bei geringstem Gewicht



## PRESSFIT BB

Neuester Tretlagerstandard für Pressfit Innenlager sorgt für grössere Rahmensteifigkeit und mehr Reifenfreiheit

## **TS** TAPERED STEERER

Steuerrohr für konischen Gabelschaft 1 1/8" auf 1.5" für höhere Steifigkeit im Steuerrohrbereich

## **PM** PM DISCMOUNT

Integrierte Post Mount Bremsattelaufnahme am Rahmen, welche einen Adapter überflüssig macht und daher Gewicht eingespart wird

## **ET** 12 X 142 E-THRU AXLE

Steckachsverbindung für die Montage des Hinterrades ermöglichen einen einfacheren Ein- und Ausbau, sowie eine höhere Steifigkeit

## **DM** DM DIRECTMOUNT

Direkt-Montage von Umwerfer und Schaltwerk sorgen für einen präziseren Schaltvorgang und eine grössere Reifenfreiheit

## AUSTRIAN ENGINEERING

Entwicklung, Konstruktion und Design durch unser innovatives und ambitioniertes Team **Born in the Austrian Alps**

## LADY SPECIFIC GEOMETRY

Speziell auf die Ergonomie und die Bedürfnisse von Frauen ausgerichtet

## **27.5**

Bezeichnung für die 27,5" MTB Serie. Eine Weiterentwicklung am MTB Sektor welche speziell für Personen entwickelt wurde, welche durch ihre Körpergröße oder denn gewünschten agileren Fahreigenschaften eine weitere Produktpalette vom Hardtail bis zum Enduro Modell in der Nakita 27,5" Palette anfinden werden! Ride on ...

## **big<sub>29</sub>**

Bezeichnung für die 29" MTB Serie. Durch die angepasste und speziell entwickelte Rahmengeometrie haben unsere Bikes nichts an ihrer Agilität verloren! Die größeren Laufräder sorgen für eine höheren Vortrieb, bessere Spurstabilität, und rollen auch wesentlich leichter über Hindernisse. Überzeugen Sie sich selbst!



NAKITA ENDURO



NAKITA  
ALL-MOUNTAIN/TRAIL



NAKITA  
CROSS-COUNTRY

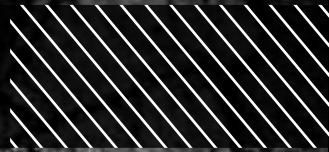

# NAKITA





# FULL SUSPENSION

FASTER - MORE COMFORT - SAFER

Engine, Blaze und Stinger ist unsere Antwort im Full Suspension Segment! In dieser Palette bieten wir vom Enduro bis zum Cross Country Bike für jeden Fahrer & Fahrstil das richtige Bike! Hochwertige Rahmen aus Carbon und High End Aluminium, die aktuellsten Federungssysteme sowie hochwertige Parts lassen keine Wünsche offen.

Born in the Austrian Alps.

# FULL SUSPENSION







FULL  
SUSPENSION

## ENGINE C PRO

160MM | 27.5"



27.5

12 X 142  
E-THRU  
AXLE



**Rahmen:** Carbon Monocoque UD, Tapered Steerer, Pressfit BB, 12x142 Rear E-Thru Axle, Direct Mount FD, Postmount Discbrake, 160mm Travel **Gabel:** Fox 34 Talas Factory CTD Adjust Fit Kashima 160 - 130mm, 15mm QR **Dämpfer:** Fox Float X CTD, Trail Adjust **Schaltung:** Shimano XTR Fullgroup 22-Gang **Kurbel:** Shimano XTR Trail **Bremsen:** Shimano XTR Trail Disc **Laufträder:** Pancho Wheels "No Tubes Ready", ZTR Flow Ex, Schwalbe Nobby Nic 27,5 x 2,35 **Anbauteile:** Lenker Race Face Next 35, 760mm, Vorbau Race Face Turbine 35, Sattelstütze Rock Shox Reverb Stealth **Sattel:** Fizik Gobi XM "Custom" **Rahmenhöhen:** 41, 46, 51cm **Farbe:** carbon matt/stealth

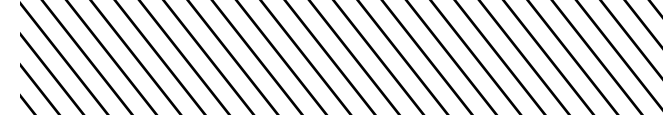

**FULL  
SUSPENSION**

**160MM | 27.5"**

# ENGINE C SL

**Rahmen:** Carbon Monocoque UD, Tapered Steerer, Pressfit BB, 12x142 Rear E-Thru Axle, Direct Mount FD, Postmount Discbrake, 160mm Travel **Gabel:** Rock Shox Pike RCT3, Dual Position 160 - 130mm, 15mm QR **Dämpfer:** Rock Shox Monarch Plus, Debon Air **Schaltung:** Sram X0 1x11-Speed **Kurbel:** Race Face Turbine **Bremsen:** Shimano XT Disc **Laufräder:** Pancho Wheels "No Tubes Ready", ZTR Flow EX, Schwalbe Nobby Nic 27,5 x 2,35 **Anbauteile:** Lenker Race Face Next 35, 760mm, Vorbau Race Face Turbine 35, Sattelstütze Rock Shox Reverb Stealth **Sattel:** Fizik Gobi XM "Custom"

**Rahmenhöhen:** 41, 46, 51cm **Farbe:** carbon matt/stealth



**27.5**

12 X 142  
E-THRU  
AXLE



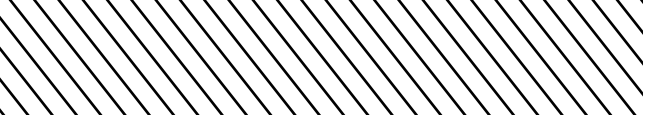

NAKITA ENDURO



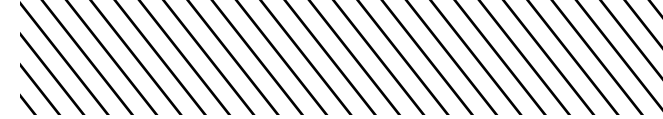

FULL  
SUSPENSION

160MM | 27.5"

# ENGINE C EXPERT

**Rahmen:** Carbon Monocoque UD, Tapered Steerer, Pressfit BB, 12x142 Rear E-Thru Axle, Direct Mount FD, Postmount Discbrake, 160mm Travel **Gabel:** Fox 34 Talas Evolution CTD 160 - 130mm, 15mm QR **Dämpfer:** Fox Float CTD BV **Schaltung:** Shimano XT Fullgroup Shadow Plus 20-Gang **Kurbel:** Shimano XT **Bremsen:** Shimano XT Disc **Laufräder:** Naben Shimano XT, Felgen Sun Ringle Helix TR 27 Custom Disc, Reifen Continental Mountain King 27,5 x 2,4 **Anbauteile:** Lenker Race Face Turbine 35, 760mm, Vorbau Race Face Turbine Basic 35, Sattelstütze Rock Shox Reverb Stealth **Sattel:** Fizik Gobi XM "Custom" **Rahmenhöhen:** 41, 46, 51cm **Farbe:** carbon matt/lightning red



27.5



12 X 142  
E-THRU  
AXLE





FULL  
SUSPENSION

## ENGINE C COMP

160MM | 27.5"

  
CARBON  
MONOCOQUE

275

12 X 142  
E-THRU  
AXLE

  
DM  
direct  
mount

  
INTERNAL CABLE  
ROUTING SYSTEM

  
AUSTRIAN  
ENGINEERING

**Rahmen:** Carbon Monocoque UD, Tapered Steerer, Pressfit BB, 12x142 Rear E-Thru Axle, Direct Mount FD, Postmount Discbrake, 160mm Travel **Gabel:** Rock Shox Pike RC, Dual Position 160 - 130mm, 15mm QR **Dämpfer:** Rock Shox Monarch RL **Schaltung:** Shimano XT 20-Gang **Kurbel:** Race Face Turbine Basic **Bremsen:** Shimano AM506 Disc **Laufräder:** Naben Shimano Deore, Felgen Sun Ringle Helix TR 27 Custom Disc, Reifen Continental Mountain King 27,5 x 2,4 **Anbauteile:** Lenker Race Face Turbine 35, 760mm, Vorbau Race Face Turbine Basic 35 Sattelstütze X-Fusion Hilo 125, BAT Remote **Sattel:** Selle Italia X1 Custom **Rahmenhöhen:** 41, 46, 51cm **Farbe:** carbon matt/lightning red

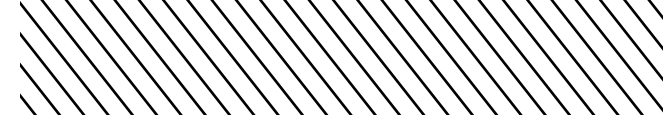

**FULL  
SUSPENSION**

**160MM | 27.5"**

# ENGINE RACE

**Rahmen:** Alu M6 Tripple Butted, Tapered Steerer, Pressfit BB, Postmount Discbrake, 12x142 Rear E-Thru Axle, ISCG05, 160mm Travel **Gabel:** Fox 36 Float, RC2 FIT New Factory 160mm, 15mm QR **Dämpfer:** Fox Float X Remote CTD **Schaltung:** Sram X1, 1x11-Speed **Kurbel:** Race Face Turbine **Bremsen:** Shimano ZEE Disc **Laufträder:** Pancho Wheels "No Tubes Ready", ZTR Flow EX. Reifen Schwalbe Hans Dampf / Rock Razor 27,5 x 2,35 **Anbauteile:** Lenker Race Face Atlas 35 800mm, Vorbau Race Face Atlas 35, Sattelstütze Rock Shox Reverb Stealth **Sattel:** Fizik Gobi XM "Custom" **Rahmenhöhen:** 38, 43, 48, 53cm **Farbe:** Alloy brushed matt/black



**27.5**

12 X 142  
E-THRU  
AXLE





FULL  
SUSPENSION

## ENGINE EXPERT

160MM | 27.5"

**T&B**  
3X BUTTED  
ALU-TECH

**275**

12 X 142  
E-THRU  
AXLE

**DM**  
direct  
mount

**A**  
AUSTRIAN  
ENGINEERING

**Rahmen:** Alu M6 Tripple Butted, Tapered Steerer, Pressfit BB, Postmount Discbrake, 12x142 Rear E-Thru Axle, ISCG05, 160mm Travel **Gabel:** Fox 34 Talas Evolution CTD 160 - 130mm, 15mm QR **Dämpfer:** Fox Float CTD BV **Schaltung:** Shimano XT Fullgroup 20-Gang **Kurbel:** Shimano XT **Bremsen:** Shimano XT Disc **Laufträder:** Naben Shimano XT, Felgen Sun Ringle Helix TR 27 Custom Disc, Reifen Continental Mountain King 27,5 x 2,4 **Anbauteile:** Lenker Race Face Turbine 35, 760mm, Vorbau Race Face Turbine Basic 35, Sattelstütze Rock Shox Reverb Stealth **Sattel:** Fizik Gobi XM "Custom" **Rahmenhöhen:** 38, 43, 48, 53cm **Farbe:** Alloy brushed matt/black

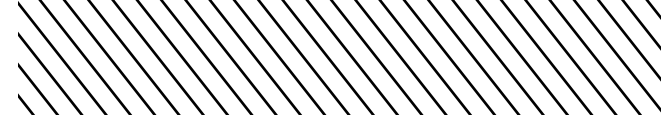

**FULL  
SUSPENSION**

**160MM | 27.5"**

# ENGINE COMP

**Rahmen:** Alu M6 Tripple Butted, Tapered Steerer, Pressfit BB, Postmount Discbrake, 12x142 Rear E-Thru Axle, ISCG05, 160mm Travel **Gabel:** Rock Shox Pike RC, Dual Position 160 - 130mm, 15mm QR **Dämpfer:** Rock Shox Monarch RL **Schaltung:** Shimano XT 20-Gang **Kurbel:** Race Face Turbine Basic **Bremsen:** Shimano AM506 Disc **Laufträder:** Naben Shimano Deore Felgen Sun Ringle Helix TR 27 Custom Disc, Reifen Continental Mountain King 27,5 x 2,4 **Anbauteile:** Lenker Race Face Turbine Vorbau Race Face Turbine Basic 35 Sattelstütze: X-Fusion Hilo 125, BAT Remote **Sattel:** Selle Italia X1 Custom **Rahmenhöhen:** 43, 48, 53cm **Farbe:** black matt/green



**27.5**

12 X 142  
E-THRU  
AXLE







## PANCHOWHEELS -

**Seit mehr als zehn Jahren stellen sie unter diesem Namen hochwertige Laufräder her.**

Von Beginn an steht Panchowheels für höchste Qualität, beste Verarbeitung und unübertroffene Individualität. An diesen Grundsätzen hat sich bis zum heutigen Tag nichts geändert.

Aufgrund der Bewegungsdynamik von Laufrädern verstehen sie die High End Produkte als Multiplikator von Fahreigenschaften und Fahrspaß. Deshalb ist es das oberste Ziel von Panchowheels, jedem Kunden genau die Laufräder zu bauen, welche seine individuellen Anforderungen optimal erfüllen. Der Kunde profitiert dabei von der langjährigen Erfahrung und der intensiven Zusammenarbeit von Panchowheels mit Spitzenathleten und Profis aus allen Bereichen des Radsports.



PANCHOWHEELS

# FULL SUSPENSION





FULL  
SUSPENSION

## BLAZE C PRO

130MM | 27.5"

  
CARBON  
MONOCOQUE

27.5

12 X 142  
E-THRU  
AXLE

  
DM  
direct  
mount

  
PANCHO  
WHEELS.COM

  
AUSTRIAN  
ENGINEERING

**Rahmen:** Carbon Monocoque UD, Tapered Steerer, Pressfit BB, 12x142 Rear E-Thru Axle, Direct Mount, Postmount Discbrake, 130mm Travel **Gabel:** Fox 32 Float Factory CTD Adjust Fit Kashima 130mm, 15mm QR **Dämpfer:** Fox Float CTD BV **Schaltung:** Shimano XTR Fullgroup 22-Gang **Kurbel:** Shimano XTR Trail **Bremsen:** Shimano XTR Trail Disc **Laufträder:** Pancho Wheels "No Tubes Ready", ZTR Flow Ex, Schwalbe Nobby Nic 27,5 x 2,35 **Anbauteile:** Lenker Easton Haven Carbon 35, 750mm, Vorbau Easton Haven 35, Sattelstütze X-Fusion Hilo SL, BAT Remote **Sattel:** Fizik Tundra "Custom" **Rahmenhöhen:** 43, 48, 53cm **Farbe:** carbon matt/stealth

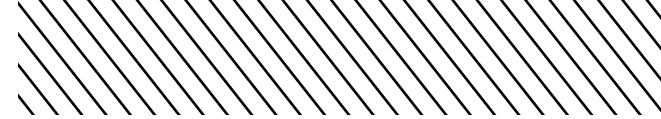

**FULL  
SUSPENSION**

**130MM | 27.5"**

# **BLAZE C EXPERT**

**Rahmen:** Carbon Monocoque UD, Tapered Steerer, Pressfit BB, 12x142 Rear E-Thru Axle, Direct Mount, Postmount Discbrake, 130mm Travel **Gabel:** Fox 32 Float Evolution CTD 130mm, 15mm QR **Dämpfer:** Fox Float CTD BV **Schaltung:** Shimano XT Fullgroup 20-Gang **Kurbel:** Shimano XT **Bremsen:** Shimano XT Disc **Laufräder:** Naben Shimano XT, Felgen Sun Ringle Helix TR 27 Custom Disc, Reifen Continental Mountain King 27,5 x 2,4 **Anbauteile:** Lenker Easton Haven 740mm, Vorbau Easton Haven, Sattelstütze X-Fusion Hilo SL, BAT Remote **Sattel:** Fizik Tundra "Custom"  
**Rahmenhöhen:** 43, 48, 53cm **Farbe:** carbon matt/lightning red



**27.5**

12 X 142  
E-THRU  
AXLE





FULL  
SUSPENSION

## BLAZE C COMP

130MM | 27.5"

  
CARBON  
MONOCOQUE

27.5

12 X 142  
E-THRU  
AXLE

  
DM  
direct  
mount

  
AUSTRIAN  
ENGINEERING

**Rahmen:** Carbon Monocoque UD, Tapered Steerer, Pressfit BB, 12x142 Rear E-Thru Axle, Direct Mount, Postmount Discbrake, 130mm Travel **Gabel:** Fox 32 Float Evolution CTD 130mm, 15mm QR **Dämpfer:** Fox Float CTD **Schaltung:** Shimano XT 30-Gang **Kurbel:** Shimano XT **Bremsen:** Shimano AM506 Disc **Laufräder:** Naben Shimano Deore, Felgen Sun Ringle Helix TR 27 Custom Disc, Reifen Continental Mountain King 27,5 x 2,4 **Anbauteile:** Lenker Nakita Custom 700mm, Vorbau Nakita Custom **Sattelstütze:** Kind Shock eTen Remote **Sattel:** Selle Italia X1 Custom  
**Rahmenhöhen:** 43, 48, 53cm **Farbe:** carbon matt/lightning red



**FULL  
SUSPENSION**

**120MM | 27.5"**



## **E-BLAZE EXPERT**

**Rahmen:** Alloy Full Suspension, Tapered Steerer, Postmount Discbrake, 120mm Rear Travel **Gabel:** Fox 32 Float Evolution, Remote Lockout, QR15MM, 120mm **Dämpfer:** Fox Float CTD **Antrieb:** Bosch Performance Line Mittelmotor **Akku:** Bosch 36V, 400 WH **Display:** LCD Display **Schaltung:** Shimano Deore XT 10-Gang **Kurbel:** Miranda Beta Plus 15Z. "Custom" **Bremsen:** Shimano Disc XT 180/180mm **Laufträder:** Naben Shimano XT Disc, Schwalbe Rocket Ron Perf. 27,5 x 2,25 **Anbauteile:** Lenker Flat Nakita Custom, Vorbau Nakita Custom, Sattelstütze Nakita Custom **Sattel:** Selle Italia Q-Bik Flow **Rahmenhöhen:** 43, 48cm **Farbe:** black matt/lightning red

**T:B**  
3X BUTTED  
ALU-TECH

**27.5**

**PM**  
disc  
mount

  
INTERNAL CABLE  
ROUTING SYSTEM

  
AUSTRIAN  
ENGINEERING



### **BOSCH PERFORMANCE LINE**

Die Performance Line ist für sportliches und kraftvolles Fahren ausgelegt und macht ihrem Namen alle Ehre. Ihr dynamischer Antrieb überzeugt mit einer leistungsstarken Unterstützung in jedem Terrain. Von flach bis steil. Von Asphalt bis Trail.

Dieselbe Kompromisslosigkeit spiegelt sich auch im Design wider. Jede einzelne Komponente vereint Eleganz und Ergonomie zu einem Höchstmaß an Ästhetik und Benutzerfreundlichkeit. Und dieses bahnbrechende Design ist jetzt noch um eine Variante reicher.

Der Bordcomputer Intuvia informiert über Reichweite, Fahrzeit, Durchschnittsgeschwindigkeit und vieles mehr, die neue Schaltempfehlung erkennt, ob Sie im smartesten Effizienzbereich der Drive Unit fahren und nennt Ihnen den optimalen Zeitpunkt zum Schalten.

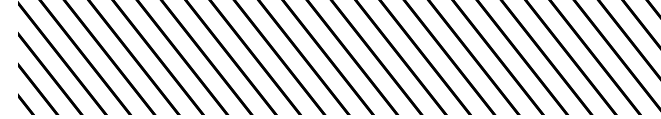

**FULL  
SUSPENSION**

**100MM | 29"**

# STINGER C PRO BIG

**Rahmen:** Carbon Monocoque UD, Tapered Steerer, E-Type Mount FD, Postmount Discbrake, 100mm Travel  
**Gabel:** Fox 32 Float 29 CTD Remote Fit Kashima, 100mm, 15mm QR **Dämpfer:** Fox Float CTD **Schaltung:** Shimano XTR Fullgroup Shadow Plus 30-Gang **Kurbel:** Shimano XTR **Bremsen:** Shimano XTR XC Disc  
**Laufräder:** SunRingle Black Flag Pro "No Tubes Ready", Continental Race King 29 x 2,2 **Anbauteile:** Lenker Fsa Slik Flat 685mm Carbon, Vorbau FSA Slik, Sattelstütze Fsa Slik Carbon **Sattel:** Selle Italia X1 Custom  
**Rahmenhöhen:** 41, 46, 51cm **Farbe:** carbon matt/orange







## STINGER C EXPERT BIG

100MM | 29"

**Rahmen:** Carbon Monocoque UD, Tapered Steerer, E-Type Mount FD, Postmount Discbrake, 100mm Travel **Gabel:** Fox 32 Float 29 CTD Remote, 100mm, 15mm QR **Dämpfer:** Fox Float CTD **Schaltung:** Shimano XT Fullgroup Shadow Plus 30-Gang **Kurbel:** Shimano XT **Bremsen:** Shimano XT Disc **Laufträder:** Naben Shimano XT, Felgen SunRingle Inferno 25 Custom Disc, Reifen Continental X-King 29 x 2,2 **Anbauteile:** Lenker Fsa Flat HB-XC-265 680mm, Vorbau Fsa OS-168, Sattelstütze Fsa SP-XC-255 **Sattel:** Selle Italia X1 Custom **Rahmenhöhen:** 41, 46, 51cm **Farbe:** carbon matt/orange



## STINGER C COMP BIG

100MM | 29"

**Rahmen:** Carbon Monocoque UD, Tapered Steerer, E-Type Mount FD, Postmount Discbrake, 100mm Travel **Gabel:** Manitou Marvel 29 Expert Milo Remote, 100mm, 15mm QR **Dämpfer:** Radium Expert **Schaltung:** Shimano XT Shadow Plus 30-Gang/S LX 30-Gang **Kurbel:** Shimano SLX **Bremsen:** Shimano AM615 Deore Disc **Laufträder:** Naben Shimano Deore, Felgen SunRingle Inferno 25 Custom Disc, Reifen Continental X-King 29 x 2,2 **Anbauteile:** Lenker Fsa Flat HB-XC-265 680mm, Vorbau Fsa OS-168, Sattelstütze Fsa SP-XC-255 **Sattel:** Selle Italia X1 Custom **Rahmenhöhen:** 41, 46, 51cm **Farbe:** carbon matt/orange

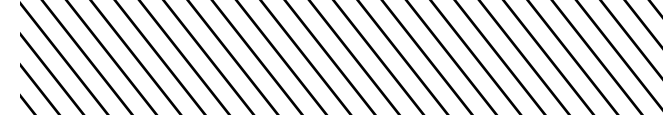

**FULL  
SUSPENSION**

**100MM | 29"**

# STINGER EXPERT

**Rahmen:** Alu 6061 Tripple Butted, Tapered Steerer, Pressfit BB, Postmount Discbrake, 100mm Travel  
**Gabel:** Fox 32 Float 29 CTD Remote, 100mm, 15mm QR **Dämpfer:** Fox Float CTD **Schaltung:** Shimano XT Fullgroup Shadow Plus 30-Gang **Kurbel:** Shimano XT **Bremsen:** Shimano XT Disc **Laufträder:** Naben Shimano XT, Felgen SunRingle Inferno 25 Custom Disc, Reifen Continental X-King 29 x 2,2 **Anbauteile:** Lenker Fsa Flat HB-XC-265 680mm, Vorbau Fsa OS-168, Sattelstütze Fsa SP-XC-255 **Sattel:** Selle Italia X1 Custom  
**Rahmenhöhen:** 42, 47, 51cm **Farbe:** black matt/white





FULL  
SUSPENSION

## STINGER COMP

100MM | 29"

**T:B**  
3X BUTTED  
ALU-TECH

**big**<sub>29</sub>

**PF**  
press  
fit BB

**PM**  
disc  
mount

**DM**  
direct  
mount

**A**  
AUSTRIAN  
ENGINEERING

**Rahmen:** Alu 6061 Tripple Butted, Tapered Steerer, Pressfit BB, Postmount Discbrake, 100mm Travel **Gabel:** Manitou Marvel 29 Comp Milo Remote, 100mm **Dämpfer:** Radium Expert **Schaltung:** Shimano XT Shadow Plus 30-Gang/SLX 30-Ga **Kurbel:** Shimano SLX **Bremsen:** Shimano AM615 Deore Disc **Laufträder:** Naben Shimano, Felgen SunRingle Inferno 25 Custom Disc, Reifen Continental X-King 29 x 2,2 **Anbauteile:** Lenker Nakita Custom Flat 700mm, Vorbau Nakita Custom, Sattelstütze Nakita Custom **Sattel:** Selle Italia X1 Custom  
**Rahmenhöhen:** 42, 47, 51cm **Farbe:** black matt/white



**FAKITA**



# HARDTAIL

SUPERLIGHT - PRECISE - DIRECT

Team C, Evo, Spider, Ram, Wildcat ist unsere Antwort im Hardtail Segment! In dieser Palette bieten wir für jeden Fahrer & Fahrstil das richtige Bike! Hochwertige Rahmen aus Carbon und Superlight Aluminium, die aktuellsten Federungssysteme sowie hochwertige Parts lassen keine Wünsche offen.

Born in the Austrian Alps.

# HARDTAIL





**HARD**  
TAIL RACE

**TEAM**  
**C PRO DI2 BIG**

**29"**



12 X 142  
 E-THRU  
 AXLE



**Rahmen:** Carbon Monocoque SL UD, Integrated Cablerouting, Tapered Steerer, Pressfit BB, Postmount Discbrake, 12x142 Rear E-Thru Axle, Direct Mount **Gabel:** Fox 32 Float 29 ICTD Remote Fit Kashima, 100mm, 15mm QR  
**Schaltung:** Shimano XTR DI2 Fullgroup 22-Gang **Kurbel:** Shimano XTR XC **Bremsen:** Shimano XTR XC Disc  
**Laufräder:** Reynolds MTN 29" XC "Black Label", Tubeless Ready, Schwalbe Rocket Ron 29 x 2,25 **Anbauteile:**  
 Lenker FSA SLK Flat 740mm Carbon, Vorbau FSA SLK, Sattelstütze FSA SLK Carbon DI2 **Sattel:** Fizik Thar "Custom"  
**Rahmenhöhen:** 38, 43, 48cm **Farbe:** carbon matt/stealth

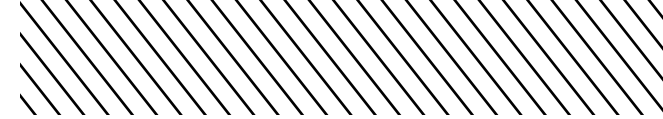

**HARD  
TAIL RACE**

**29"**

**TEAM  
C PRO RS1 BIG**

**Rahmen:** Carbon Monocoque SL UD, Integrated Cablerouting, Tapered Steerer, Pressfit BB, Postmount Discbrake, 12x142 Rear E-Thru Axle, Direct Mount **Gabel:** Rock Shox RS1, Remote, 100mm, 15mm QR **Schaltung:** Sram XO 1x11-Speed **Kurbel:** Race Face Next SL **Bremsen:** Shimano XTR XC Disc **Laufräder:** Naben XO Predictive Steering, Felgen ZTR Crest „No Tubes Ready“, Schwalbe Rocket Ron 29 x 2,25 **Anbauteile:** Lenker Easton EC70, 720mm, Vorbau Easton EC90 SL, Sattel Rock Shox Reverb Stealth **Sattel:** Fizik Thar "Custom"  
**Rahmenhöhen:** 38, 43, 48cm **Farbe:** carbon matt/stealth



12 X 142  
E-THRU  
AXLE







**HARD**  
TAIL RACE

29"

## TEAM C PRO HILL BIG

  
CARBON  
MONOCOQUE

**big**<sub>29</sub>

12 X 142  
E-THRU  
AXLE

**PM**  
disc  
mount

**DM**  
direct  
mount

  
AUSTRIAN  
ENGINEERING

**Rahmen:** Carbon Monocoque SL UD, Integrated Cablerouting, Tapered Steerer, Pressfit BB, Postmount Discbrake, 12x142 Rear E-Thru Axle, Direct Mount **Gabel:** Carbon Monocoque SL UD, 15mm QR **Schaltung:** Sram X0 1x11-Speed **Kurbel:** Race Face Next SL **Bremsen:** Shimano XTR XC Disc **Laufträder:** Reynolds MTN 29" XC "Black Label", Tubeless Ready, Schwalbe Thunder Burt 29 x 2,10 **Anbauteile:** Lenker Easton EC70, 720mm, Vorbau Easton EC90 SL, Sattelstütze Easton EC70 **Sattel:** Fizik Thar "Custom"  
**Rahmenhöhen:** 38,43,48cm **Farbe:** carbon matt/stealth

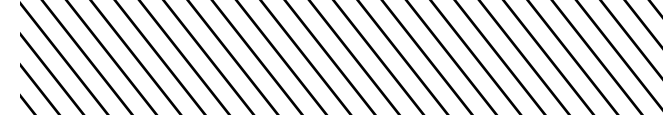

**HARD  
TAIL RACE**

**29"**

**TEAM  
C PRO BIG**

**Rahmen:** Carbon Monocoque SL UD, Integrated Cablerouting, Tapered Steerer, Pressfit BB, Postmount Discbrake, 12x142 Rear E-Thru Axle, Direct Mount **Gabel:** Fox 32 Float Factory 29 CTD Remote Fit Kashima, 100mm, 15mm QR **Schaltung:** Shimano XTR Fullgroup 22-Gang **Kurbel:** Shimano XTR XC **Bremsen:** Shimano XTR XC Disc **Laufträder:** Naben DT Swiss, Felgen ZTR Crest "No Tubes Ready", Schwalbe Rocket Ron 29 x 2,25 **Anbauteile:** Lenker Easton EC70, 720mm, Vorbau Easton EC70, Sattelstütze Easton EC70 **Sattel:** Fizik Thar "Custom" **Rahmenhöhen:** 38, 43, 48cm **Farbe:** carbon matt/stealth



12 X 142  
E-THRU  
AXLE





**HARD  
TAIL RACE**

## TEAM C PRO

27.5"



27.5

12 X 142  
E-THRU  
AXLE



**Rahmen:** Carbon Monocoque SL UD, Integrated Cablerouting, Tapered Steerer, Pressfit BB, Postmount Discbrake, 12x142 Rear E-Thru Axle, Direct Mount **Gabel:** Fox 32 Float 27,5 CTD Remote Fit Kashima, 100mm, 15mm QR **Schaltung:** Shimano XTR Fullgroup 22-Gang **Kurbel:** Shimano XTR XC **Bremsen:** Shimano XTR XC Disc **Laufräder:** Naben DT Swiss, Felgen ZTR Crest "No Tubes Ready", Schwalbe Rocket Ron 27,5 x 2,25 **Anbauteile:** Lenker Easton EC70 720mm, Vorbau Easton EC70, Sattelstütze Easton EC70 **Sattel:** Fizik Tundra "Custom" **Rahmenhöhen:** 43, 48, 53cm **Farbe:** carbon matt/white

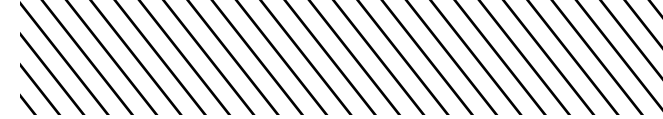

# HARD TAIL RACE

29"

# TEAM C SL BIG

**Rahmen:** Carbon Monocoque UD, Integrated Cablerouting, Tapered Steerer, Pressfit BB, Postmount Discbrake, 12x142 Rear E-Thru Axle, Direct Mount **Gabel:** Rock Shox SID RLT 29, Remote Lockout, 100mm, 15mm QR  
**Schaltung:** Shimano XT Fullgroup 20-Gang **Kurbel:** Shimano XT **Bremsen:** Shimano XT Disc **Laufträder:** Naben DT Swiss, Felgen ZTR Crest "No Tubes Ready", Schwalbe Rocket Ron 29 x 2,25 **Anbauteile:** Lenker Easton EA70, 720mm, Vorbau Easton EA70, Sattelstütze Easton EA70 **Sattel:** Fizik Thar "Custom"  
**Rahmenhöhen:** 43, 48, 53cm **Farbe:** carbon matt/lightning red



12 X 142  
E-THRU  
AXLE





**HARD**  
TAIL RACE

27.5"

## TEAM CSL

  
CARBON  
MONOCOQUE

27.5

12 X 142  
E-THRU  
AXLE

  
PM  
disc  
mount

  
DM  
direct  
mount

  
AUSTRIAN  
ENGINEERING

**Rahmen:** Carbon Monocoque UD, Integrated Cablerouting, Tapered Steerer, Pressfit BB, Postmount Discbrake, 12x142 Rear E-Thru Axle, Direct Mount **Gabel:** Rock Shox SID RLT, Remote Lockout, 100mm, 15mm QR **Schaltung:** Shimano XT Fullgroup 20-Gang **Kurbel:** Shimano XT **Bremsen:** Shimano XT Disc **Laufträder:** Naben DT Swiss, Felgen ZTR Crest "No Tubes Ready", Schwalbe Rocket Ron 27,5 x 2,25 **Anbauteile:** Lenker Easton EA70 720mm, Vorbau Easton EA70, Sattelstütze Easton EA70 **Sattel:** Fizik Thar "Custom" **Rahmenhöhen:** 38, 43, 48, 53cm **Farbe:** carbon matt/lightning red

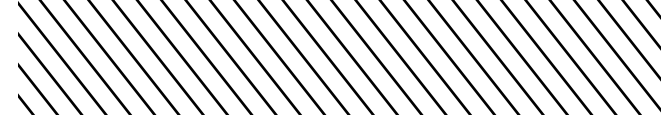

**HARD  
TAIL RACE**

**29"**

**TEAM  
C EXPERT BIG**

**Rahmen:** Carbon Monocoque UD, Integrated Cablerouting, Tapered Steerer, Pressfit BB, Postmount Discbrake, 12x142 Rear E-Thru Axle, Direct Mount **Gabel:** Fox 32 Float 29 CTD Remote, 100mm, 15mm QR **Schaltung:** Shimano XT Fullgroup 30-Gang **Kurbel:** Shimano XT **Bremsen:** Shimano XT Disc **Laufträder:** Naben Shimano XT, Felgen Sun Ringle Helix TR 25 Custom Disc, Reifen Schwalbe Rocket Ron 29 x 2,25 **Anbauteile:** Lenker Nakita Custom Flat 700mm, Vorbau Nakita Custom, Sattelstütze Nakita Custom **Sattel:** Selle Italia X1 Custom **Rahmenhöhen:** 43, 48, 53cm **Farbe:** carbon matt/lightning red



12 X 142  
E-THRU  
A X L E





**HARD  
TAIL RACE**

## TEAM C EXPERT

27.5"

**CARBON**  
MONOCOQUE

**27.5**

12 X 142  
E-THRU  
AXLE

**PM**  
disc  
mount

**DM**  
direct  
mount

**A**  
AUSTRIAN  
ENGINEERING

**Rahmen:** Carbon Monocoque UD, Integrated Cablerouting, Tapered Steerer, Pressfit BB, Postmount Discbrake, 12x142 Rear E-Thru Axle, Direct Mount **Gabel:** Fox 32 Float 27,5 CTD Remote, 100mm, 15mm QR **Schaltung:** Shimano XT Fullgroup 30-Gang **Kurbel:** Shimano XT **Bremsen:** Shimano XT Disc **Laufräder:** Naben Shimano XT, Felgen Sun Ringle Helix TR25 Custom Disc, Schwalbe Rocket Ron 27,5 x 2,25 **Anbauteile:** Lenker Nakita Flat Custom 700mm, Vorbau Nakita Custom, Sattelstütze Nakita Custom **Sattel:** Selle Italia X1 Custom **Rahmenhöhen:** 38, 43, 48, 53cm **Farbe:** carbon matt/lightning red

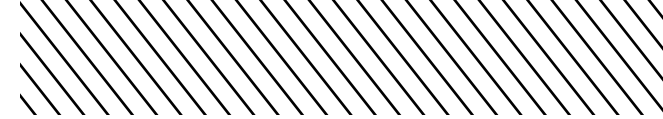

**HARD  
TAIL RACE**

**29"**

**TEAM  
C RACE BIG**

**Rahmen:** Carbon Monocoque UD, Integrated Cablerouting, Tapered Steerer, Pressfit BB, Postmount Discbrake  
**Gabel:** Rock Shox Reba RL, Remote Lockout, 100mm, 15mm QR **Schaltung:** Shimano XT 30-Gang  
**Kurbel:** Shimano XT **Bremsen:** Shimano AM506 Disc **Laufträder:** Naben Shimano Deore, Felgen Sun Ringle Inferno 25 Custom Disc, Reifen Schwalbe Rocket Ron 29 x 2,25 **Anbauteile:** Lenker Nakita Custom Flat 700mm, Vorbau Nakita Custom, Sattelstütze Nakita Custom **Sattel:** Nakita VL-1205 Custom  
**Rahmenhöhen:** 43, 48, 53cm **Farbe:** carbon matt/green







## TEAM C RACE

HARD  
TAIL RACE

27.5"



27.5



**Rahmen:** Carbon Monocoque UD, Integrated Cablerouting, Tapered Steerer, Pressfit BB, Postmount Discbrake, Direct Mount RD **Gabel:** Rock Shox Reba RL, Remote Lockout, 100mm **Schaltung:** Shimano XT 30-Gang **Kurbel:** Shimano XT **Bremsen:** Shimano M506 Disc **Laufräder:** Naben Shimano Deore, Felgen Sun Ringle Inferno 25 Custom Disc, Reifen Schwalbe Rocket Ron 27,5 x 2,25 **Anbauteile:** Lenker Nakita Custom Flat 700mm, Vorbau Nakita Custom, Sattelstütze Nakita Custom **Sattel:** Velo VL-1205 Nakita Custom **Rahmenhöhen:** 38, 43, 48, 53cm **Farbe:** carbon matt/blue

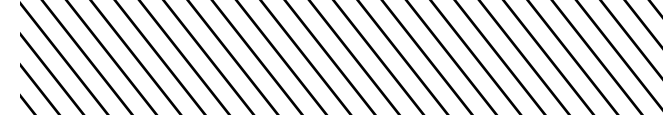

**HARD  
TAIL RACE**

**29"**

**TEAM  
C COMP BIG**

**Rahmen:** Carbon Monocoque UD, Integrated Cablerouting, Tapered Steerer, Pressfit BB, Postmount Discbrake  
**Gabel:** Manitou Marvel Limited, Remote Lockout, 100mm **Schaltung:** Shimano XT 30-Gang  
**Kurbel:** Shimano XT **Bremsen:** Shimano M355 Disc **Laufräder:** Naben Shimano, Felgen Sun Ringle Inferno 25 Custom Disc, Reifen Continental X-King 29 x 2,2 **Anbauteile:** Lenker Nakita Custom Flat 700mm, Vorbau Nakita Custom, Sattelstütze Nakita Custom **Sattel:** Nakita VL-1205 Custom  
**Rahmenhöhen:** 43, 48, 53cm **Farbe:** carbon matt/green





**HARD  
TAIL RACE**

## TEAM C COMP

27.5"



27.5



**Rahmen:** Carbon Monocoque UD, Integrated Cablerouting, Tapered Steerer, Pressfit BB, Postmount Discbrake  
**Gabel:** Manitou Marvel Limited 27,5, Milo Remote, 100mm **Schaltung:** Shimano XT 30-Gang  
**Kurbel:** Shimano XT **Bremsen:** Shimano M355 Disc **Laufräder:** Naben Shimano, Felgen Sun Ringle Inferno 25 Custom Disc, Reifen Continental X-King 27,5 x 2,2 **Anbauteile:** Lenker Nakita Custom Flat 700mm, Vorbau Nakita Custom, Sattelstütze Nakita Custom **Sattel:** Velo VL-1205 Nakita Custom  
**Rahmenhöhen:** 38, 43, 48, 53cm **Farbe:** carbon matt/blue

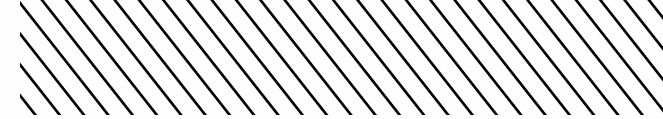

C PRO RS1 BIG

### RS-1

25 Jahre nach der ersten RS-1, der Federgabel, die die Mountainbike-Szene revolutioniert hat, schafft es RockShox erneut. Ein völlig neues Gestell-Design, bei dem Schaftrrohr, Gabelkrone und Gabelbeine der Federgabel in einen einzelnen Carbon-Rahmen integriert werden. Der brandneue Beschleunigungsdämpfer kombiniert unglaubliche Leistung bei kleinen Schlägen mit extrem effizientem Lockout. Zu guter Letzt konnten wir mit Predictive Steering, einer neu entworfenen Schnittstelle zwischen Nabe und Ausfallenden, eine invertierte Federgabel entwickeln, die leicht genug für XC-Rennen und steif genug für Trail-Rennen ist.



ICH LIEBE NATUR

Ich liebe Performance



KAUFTIPP  
11/12  
Mountain  
BIKES

Men's Tiak Jacket



Green Shape ist Deine VAUDE Garantie für umweltfreundliche Produkte – aus nachhaltigen Materialien und ressourcenschonender Herstellung. Wir unterstützen die Naturschutzarbeit des WWF und setzen uns als Mitglied der Fair Wear Foundation für faire Arbeitsbedingungen in unseren Produktionsstätten ein. VAUDE steht für grüne Performance, die so funktionell wie nachhaltig ist. [vaude.com](https://www.vaude.com)



**VAUDE**

*The Spirit of Mountain Sports*

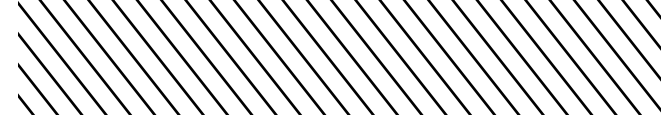

**HARD  
TAIL RACE**

**29"**

**EVO  
LIMITED BIG**

**Rahmen:** Alu 6066 SL, Tapered Steerer, Pressfit BB, Postmount Discbrake, Direct Mount, Smooth welding, 12x142 Rear E-Thru Axle **Gabel:** Fox 32 Float 29 CTD Remote, 100mm, 15mm QR **Schaltung:** Shimano XT Fullgroup 30-Gang **Kurbel:** Shimano XT **Bremsen:** Shimano XT Disc **Laufräder:** Naben Shimano XT, Felgen Sun Ringle Helix TR 25 Custom Disc, Reifen Schwalbe Rocket Ron 29 x 2,25 **Anbauteile:** Lenker Nakita Custom Flat 700mm, Vorbau Nakita Custom, Sattelstütze Nakita Custom **Sattel:** Selle Italia X1 Custom **Rahmenhöhen:** 43, 48, 53cm **Farbe:** black matt/stealth



12 X 142  
E-THRU  
AXLE





**HARD  
TAIL RACE**

**EVO  
LIMITED**

**27.5"**

**T:B**  
3X BUTTED  
ALU-TECH

**27.5**

12 X 142  
E-THRU  
AXLE

**PM**  
disc  
mount

**DM**  
direct  
mount

**A**  
AUSTRIAN  
ENGINEERING

**Rahmen:** Alu 6066 SL, Tapered Steerer, Pressfit BB, Postmount Discbrake, Direct Mount FD & RD, Smooth welding, 12x142 Rear E-Thru Axle **Gabel:** Fox 32 Float 27,5 CTD Remote, 100mm, 15mm QR **Schaltung:** Shimano XT Fullgroup 30-Gang **Kurbel:** Shimano XT **Bremsen:** Shimano XT Disc **Laufräder:** Naben Shimano XT, Felgen Sun Ringle Helix TR 25 Custom Disc, Reifen Schwalbe Rocket Ron 27,5 x 2,25 **Anbauteile:** Lenker Nakita Flat Custom 700mm, Vorbau Nakita Custom Sattelstütze Nakita Custom **Sattel:** Selle Italia X1 Custom **Rahmenhöhen:** 38, 43, 48, 53cm **Farbe:** black matt/stealth

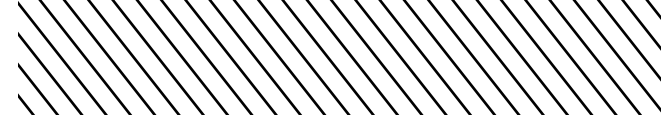

**HARD  
TAIL SPORT**

**29"**

# SPIDER 9.5 BIG

**Rahmen:** Alu 6061 Double Butted, Tapered Steerer, Pressfit BB, Monocoque Shape, Postmount Discbrake, Integrated Cablerouting integrated Kickstandmount, Direct Mount **Gabel:** Rock Shox Reba RL, Remote Lockout, 100mm **Schaltung:** Shimano XT 30-Gang **Kurbel:** Shimano XT **Bremsen:** Shimano M506 Disc **Laufräder:** Naben Shimano Deore, Felgen SunRingle Inferno 25 Custom Disc, Reifen Schwalbe Rocket Ron 29 x 2,25 **Anbauteile:** Lenker Nakita Custom Flat 700mm, Vorbau Nakita Custom, Sattelstütze Nakita Custom **Sattel:** Velo VL-1205 Nakita Custom **Rahmenhöhen:** 43, 48, 53cm **Farbe:** black matt/white







**HARD**  
TAIL SPORT

## SPIDER

9.5

27.5"

**DB**  
2X BUTTED  
ALU-TECH

27.5

**ICS**  
INTERNAL CABLE  
ROUTING SYSTEM

**DM**  
direct  
mount

**PF**  
press  
fit BB

**A**  
AUSTRIAN  
ENGINEERING

**Rahmen:** Alu 6061 Double Butted, Tapered Steerer, Pressfit BB, Monocoque Shape, Postmount Discbrake, integrated Kickstandmount, Direct Mount RD **Gabel:** Rock Shox Reba RL, Remote Lockout, 100mm **Schaltung:** Shimano XT 30-Gang **Kurbel:** Shimano XT **Bremsen:** Shimano M506 Disc **Laufräder:** Naben Shimano Deore, Felgen Sun Ringle Inferno 25 Custom Disc, Reifen Continental X-King 27,5 x 2,2 **Anbauteile:** Lenker Nakita Custom Riser 680mm, Vorbau Nakita Custom, Sattelstütze Nakita Custom **Sattel:** Velo VL-1205 Nakita Custom **Rahmenhöhen:** 38, 43, 48, 53cm **Farbe:** black matt/white

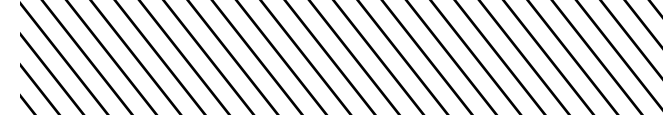

**HARD  
TAIL SPORT**

**29"**

# SPIDER 7.5 BIG

**Rahmen:** Alu 6061 Double Butted, Tapered Steerer, Pressfit BB, Monocoque Shape, Postmount Discbrake, Integrated Cablerouting, integrated Kickstandmount, Direct Mount **Gabel:** Manitou Marvel Limited Air, Remote Lockout, 100mm **Schaltung:** Shimano XT 30-Gang **Kurbel:** Shimano XT **Bremsen:** Shimano M355 Disc **Laufträder:** Naben Shimano, Felgen Sun Ringle Inferno 25 Custom Disc, Reifen Continental X-King 29 x 2,2 **Anbauteile:** Lenker Nakita Custom Flat 700mm, Vorbau Nakita Custom, Sattelstütze Nakita Custom **Sattel:** Velo VL-1205 Nakita Custom **Rahmenhöhen:** 43, 48, 53, 57cm **Farbe:** black matt/white





**HARD  
TAIL SPORT**

# SPIDER 7.5

27.5"

**DB**  
2X BUTTED  
ALU-TECH

**27.5**

  
INTERNAL CABLE  
ROUTING SYSTEM

**DM**  
direct  
mount

**PF**  
press  
fit BB

  
AUSTRIAN  
ENGINEERING

**Rahmen:** Alu 6061 Double Butted, Tapered Steerer, Pressfit BB, Monocoque Shape, Postmount Discbrake, integrated Kickstandmount, Direct Mount RD **Gabel:** Manitou Marvel Limited Air, Remote Lockout, 100mm **Schaltung:** Shimano XT 30-Gang **Kurbel:** Shimano XT **Bremsen:** Shimano M355 Disc **Laufräder:** Naben Shimano Deore, Felgen Sun Ringle Inferno 25 Custom Disc, Reifen Continental X-King 27,5 x 2,2 **Anbauteile:** Lenker Nakita Custom Riser 680mm, Vorbau Nakita Custom, Sattelstütze Nakita Custom **Sattel:** Velo VL-1205 Nakita Custom **Rahmenhöhen:** 38, 43, 48, 53cm **Farbe:** black matt/white

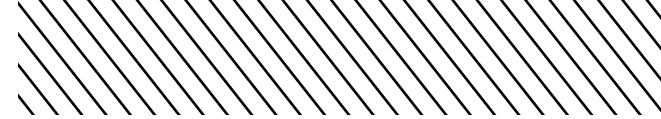

**HARD**  
TAIL SPORT

29"

# SPIDER 5.5 BIG

**Rahmen:** Alu 6061 Double Butted, Monocoque Shape, Postmount Discbrake, integrated Kickstandmount, Direct Mount RD **Gabel:** Rock Shox XC30 TK Solo Air, Lockout, 100mm **Schaltung:** Shimano XT 30-Gang **Kurbel:** Shimano FCM612 **Bremsen:** Shimano M355 Disc **Laufräder:** Naben Shimano, Felgen Sun Ringle Inferno 25 Custom Disc, Reifen Continental X-King 29 x 2,2 **Anbauteile:** Lenker Nakita Custom Flat 700mm, Vorbau Nakita Custom, Sattelstütze Nakita Custom **Sattel:** Velo VL-1205 Nakita Custom **Rahmenhöhen:** 43, 48, 53cm **Farbe:** brushed chrome/lightning red





**HARD  
TAIL SPORT**

## SPIDER

5.5

27.5"

**DB**  
2X BUTTED  
ALU-TECH

27.5

**DM**  
direct  
mount

**A**  
AUSTRIAN  
ENGINEERING

**Rahmen:** Alu 6061 Double Butted, Monocoque Shape, Postmount Discbrake, integrated Kickstandmount, Direct Mount RD **Gabel:** Rock Shox XC30 TK Solo Air, 100mm **Schaltung:** Shimano XT 30-Gang **Kurbel:** Shimano FCM612 **Bremsen:** Shimano M355 Disc **Laufräder:** Naben Shimano Deore, Felgen Sun Ringle Inferno 25 Custom Disc, Reifen Continental X-King 27,5 x 2,2 **Anbauteile:** Lenker Nakita Custom Riser 680mm, Vorbau Nakita Custom, Sattelstütze Nakita Custom **Sattel:** Velo VL-1205 Nakita Custom  
**Rahmenhöhen:** 38, 43, 48, 53cm **Farbe:** brushed chrome/blue

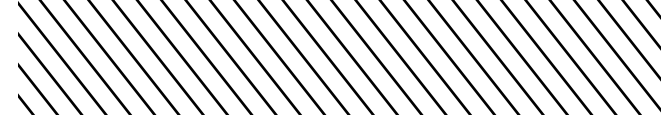

**HARD  
TAIL SPORT**

**29"**

**RAM  
5.5 BIG**

**Rahmen:** Alu 6061, Postmount Discbrake, integrated Kickstandmount **Gabel:** Suntour XCM RL, Remote Lockout, 100mm **Schaltung:** Shimano XT 30-Gang **Kurbel:** Shimano M523 **Bremsen:** Tektro HDM-290 Disc **Laufräder:** Naben Alu, Felgen Sun Ringle Inferno 25 Custom Disc, Reifen Schwalbe Rapid Rob 29 x 2,25 **Anbauteile:** Lenker Nakita Custom Rise 680mm, Vorbau Nakita Custom, Sattelstütze Nakita Custom **Sattel:** Velo VL-1205 Nakita Custom **Rahmenhöhen:** 43, 48, 53cm **Farbe:** grey matt/blue





**HARD**  
TAIL SPORT

**RAM**  
5.5

27.5"

**PG**  
ALU-TECH

**27.5**

**PM**  
disc  
mount

**A**  
AUSTRIAN  
ENGINEERING

**Rahmen:** Alu 6061, Postmount Discbrake, integrated Kickstandmount **Gabel:** Suntour XCM RL, Remote Lockout, 100mm **Schaltung:** Shimano XT 30-Gang **Kurbel:** Shimano M523 **Bremsen:** Tektro HDM-290 Disc **Laufräder:** Naben Alu, Felgen XCD Disc, Reifen Schwalbe Rapid Rob 27,5 x 2,25 **Anbauteile:** Lenker Nakita Custom Rise 680mm, Vorbau Nakita Custom, Sattelstütze Nakita Custom **Sattel:** Velo VL-1205 Nakita Custom **Rahmenhöhen:** 38, 43, 48, 53cm **Farbe:** grey matt/lightning red

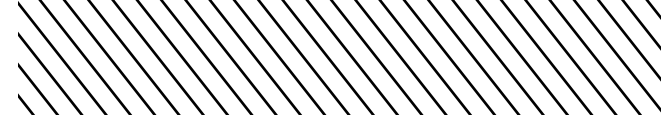

**HARD**  
TAIL SPORT

29"

**RAM**  
3.5 BIG

**Rahmen:** Alu 6061, Postmount Discbrake, integrated Kickstandmount **Gabel:** Suntour XCM HLO, Lockout, 100mm **Schaltung:** Shimano XT 27-Gang **Kurbel:** Shimano FCM4000 (40/30/22) **Bremsen:** Tektro HDM-290 Disc **Laufträder:** Naben Alu, Felgen XCD Disc, Reifen Impac Ridgepac 29 x 2,1 **Anbauteile:** Lenker Nakita Custom Rise 680mm, Vorbau Nakita Custom, Sattelstütze Nakita Custom **Sattel:** Velo VL-1205 Nakita Custom **Rahmenhöhen:** 43, 48, 53cm **Farbe:** black matt/yellow

**PG**  
ALU-TECH

**big**<sub>29</sub>

**PM**  
disc  
mount

**AUSTRIAN**  
ENGINEERING





**HARD  
TAIL SPORT**

**RAM**  
3.5

27.5"

**PG**  
ALU-TECH

**27.5**

**PM**  
disc  
mount

**A**  
AUSTRIAN  
ENGINEERING

**Rahmen:** Alu 6061, Postmount Discbrake, integrated Kickstandmount **Gabel:** Suntour XCM HLO, Lockout, 100mm **Schaltung:** Shimano XT 27-Gang **Kurbel:** Shimano M4000 (40/30/22) **Bremsen:** Tektro HDM-290 Disc **Laufräder:** Naben Alu, Felgen XCD Disc, Reifen Schwalbe Rapid Rob 27,5 x 2,25 **Anbauteile:** Lenker Nakita Custom Rise 660mm, Vorbau Nakita Custom, Sattelstütze Nakita Custom **Sattel:** Velo VL-1205 Nakita Custom **Rahmenhöhen:** 38, 43, 48, 53cm **Farbe:** black matt/green

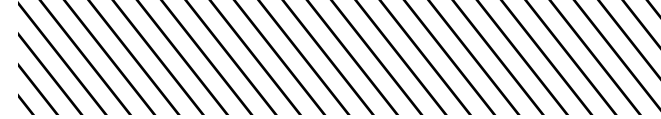

**HARD**  
TAIL SPORT

27.5"

**RAM**  
2.5

**Rahmen:** Alu 6061, Postmount Discbrake, integrated Kickstandmount **Gabel:** Suntour XCT HLO, 100mm **Schaltung:** Shimano Alivio 24-Gang **Kurbel:** Shimano M171 **Bremsen:** Tektro HDM-290 Disc **Laufträder:** Naben Alu, Felgen XCD Disc, Reifen Schwalbe Rapid Rob 27,5 x 2,25 **Anbauteile:** Lenker Nakita Riser 660mm, Vorbau Nakita Custom, Sattelstütze Nakita Custom **Sattel:** Velo VL-1205 Nakita Custom **Rahmenhöhen:** 43, 48, 53cm **Farbe:** black matt/yellow

**PG**  
ALU-TECH

**27.5**

**PM**  
disc  
mount

**AUSTRIAN**  
ENGINEERING



**HARD  
TAIL SPORT**

## RAM 1.5

27.5"

**Rahmen:** Alu 6061, Postmount Discbrake, integrated Kickstandmount **Gabel:** Suntour M3030, 100mm **Schaltung:** Shimano Acera 24-Gang **Kurbel:** Shimano M131 **Bremsen:** Shimano M375 Disc **Laufräder:** Naben Alu, Felgen XCD Disc, Reifen Schwalbe Rapid Rob 27,5 x 2,25 **Anbauteile:** Lenker Nakita Riser 660mm, Vorbau Nakita Custom, Sattelstütze Nakita Custom **Sattel:** Velo VL-1205 Nakita Custom **Rahmenhöhen:** 38, 43, 48cm **Farbe:** blue glossy/lightning red

**PG**  
ALU-TECH

**27.5**

**PM**  
disc  
mount

**A**  
AUSTRIAN  
ENGINEERING

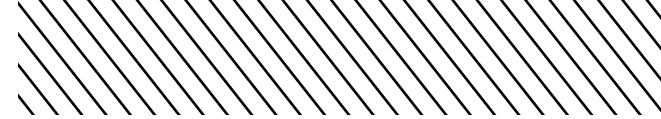

**HARD**  
TAIL SPORT

27.5"

**RAM**  
1.0

**Rahmen:** Alu 6061, Postmount Discbrake, integrated Kickstandmount **Gabel:** Suntour M3030, 100mm **Schaltung:** Shimano Acera 24-Gang **Kurbel:** Shimano M131 **Bremsen:** V-Brake  
**Laufräder:** Naben Alu, Felgen Alu, Reifen Schwalbe 27,5 x 2,25 **Anbauteile:** Lenker Nakita Riser 660mm, Vorbau Nakita Custom, Sattelstütze Nakita Custom **Sattel:** Velo VL-1205 Nakita Custom  
**Rahmenhöhen:** 38, 43, 48cm **Farbe:** white glossy/blue

**PG**  
ALU-TECH

**27.5**

**PM**  
disc  
mount

**AUSTRIAN**  
ENGINEERING



# CLAW FATBIKE

**FAT  
BIKE**  
27.5"

**DB**  
2X BUTTED  
ALU-TECH

**IC**  
INTERNAL CABLE  
ROUTING SYSTEM

**PF**  
press  
fit BB

**PM**  
disc  
mount

**DM**  
direct  
mount

**AE**  
AUSTRIAN  
ENGINEERING

**Rahmen:** Alu 6061 Double Butted, Tapered Steerer, Pressfit BB, Monocoque Shape, Postmount Discbrake, Integrated Cablerouting, Direct Mount **Gabel:** Alloy, Monocoque Shape, 15mm QR **Schaltung:** Sram X1 1x11-Speed **Kurbel:** Sram X1, 30Z. **Bremsen:** Shimano AM615 Disc **Laufräder:** Naben Salsa Alloy Disc, Felgen Salsa Alloy, Reifen Kenda Juggernaut 26 x 4.0 **Anbauteile:** Lenker Race Face Turbine 35, 760mm Vorbau Race Face Turbine35, Sattelstütze Rock Shox Reverb Stealth **Sattel:** Fizik Tundra "Custom"  
**Rahmenhöhen:** 43, 48, 53cm **Farbe:** grey matt/lightning red

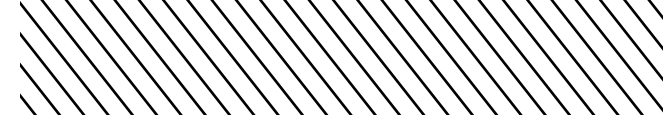

**HARD  
TAIL LADYS**

**27.5"**

# WILDCAT 7.5

**Rahmen:** Alu 6061 Double Butted Lady Specific Frame, Postmount Discbrake, integrated Kickstandmount, Direct Mount RD **Gabel:** Rock Shox XC30 TK Solo Air, Lockout, 100mm **Schaltung:** Shimano XT 30-Gang **Kurbel:** Shimano XT **Bremsen:** Shimano M355 Disc **Laufträder:** Naben Shimano, Felgen Sun Ringle Inferno 25 Custom Disc, Reifen Continental X-King 27,5 x 2,2 **Anbauteile:** Lenker Nakita Custom Riser 640mm, Vorbau Nakita Custom, Sattelstütze Nakita Custom **Sattel:** Velo VL-4125 Nakita Custom **Rahmenhöhen:** 42, 46cm **Farbe:** black matt/white



**27.5**





**HARD**  
TAIL LADYS

## WILDCAT

5.5

27.5"

**DB**  
2X BUTTED  
ALU-TECH

27.5

LADY  
SPECIFIC  
GEOMETRIE

**PM**  
disc  
mount

**DM**  
direct  
mount

AUSTRIAN  
ENGINEERING

**Rahmen:** Alu 6061 Double Butted Lady Specific Frame, Postmount Discbrake, integrated Kickstandmount  
**Gabel:** Suntour XCM-HLO, Lockout, 100mm **Schaltung:** Shimano XT 27-Gang **Kurbel:** Shimano M4000 (40/30/22)  
**Bremsen:** Tektro HDM-290 Disc **Laufträder:** Naben Alu, Felgen Sun Ringle Inferno 25 Custom Disc, Reifen Schwalbe Rapid Rob 27,5 x 2,25 **Anbauteile:** Lenker Nakita Custom Riser 640mm, Vorbau Nakita Custom, Sattelstütze Nakita Custom **Sattel:** Velo VL-4125 Nakita Custom  
**Rahmenhöhen:** 36, 42, 46cm **Farbe:** black matt/purple

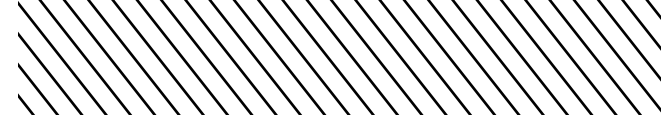

**HARD  
TAIL LADYS**

**27.5"**

# WILDCAT 3.5

**Rahmen:** Alu 6061 Double Butted Lady Specific Frame, Postmount Discbrake, integrated Kickstandmount  
**Gabel:** Suntour XCT-HLO, Lockout, 100mm **Schaltung:** Shimano Alivio 24-Gang **Kurbel:** Shimano M171  
**Bremsen:** Tektro HDM-290 Disc **Laufträder:** Naben Alu, Felgen XCD Disc, Reifen Schwalbe Rapid Rob 27,5 x 2,25 **Anbauteile:** Lenker Nakita Custom Riser 640mm, Vorbau Nakita Custom, Sattelstütze Nakita Custom **Sattel:** Velo VL-4125 Nakita Custom **Rahmenhöhen:** 36, 42, 46cm **Farbe:** black matt/blue



**275**







**HARD**  
TAIL LADYS

## WILDCAT

3.0

27.5"

**DB**  
2X BUTTED  
ALU-TECH

**A**  
AUSTRIAN  
ENGINEERING

27.5

**LADY**  
SPECIFIC  
GEOMETRIE

**Rahmen:** Alu 6061 Double Butted Lady Specific Frame, Postmount Discbrake, integrated Kickstandmount  
**Gabel:** Suntour M3030, 100mm **Schaltung:** Shimano Acera 24-Gang **Kurbel:** Shimano M171  
**Bremsen:** V-Brake **Laufträder:** Naben Alu, Felgen Alu, Reifen Schwalbe Rapid Rob 27,5 x 2,25  
**Anbauteile:** Lenker Nakita Custom Riser 640mm, Vorbau Nakita Custom, Sattelstütze Nakita Custom  
**Sattel:** Velo VL-4125 Nakita Custom **Rahmenhöhen:** 36, 42, 46cm **Farbe:** grey matt/tourquise



FAKITA



**KIDZ**

Kidz ist unsere Antwort im sportlichen Einstieg für unseren Offroad Nachwuchs! In dieser Palette bieten wir vom hochwertig angepassten Aluminiumrahmen, abgestimmten Federungssystemen, sowie auserwählten Parts für die ersten Ausflüge ins Gelände keine Wünsche mehr offen!

**Born in the Austrian Alps.**

---



24"

**KIDZ**  
3.5

**Rahmen:** Alu 7005 **Gabel:** Suntour M3020-P24 24" **Schaltung:** Shimano Acera 24-Gang **Kurbel:** Suntour XCCT 102 **Bremsen:** Hayes MX5 mech. Disc **Laufräder:** Naben Alu Disc, Felgen XCD Disc, Reifen Kenda 24 x 1,95 **Anbauteile:** Lenker Nakita Riser Custom 600mm, Vorbau Nakita Custom, Sattelstütze Nakita Custom **Sattel:** Active KIDZ "Nakita Custom" **Rahmenhöhen:** 35cm **Farbe:** dark grey matt/blue

**PG**  
ALU-TECH

**PM**  
disc  
mount

**AUSTRIAN**  
ENGINEERING



# KIDZ

3.0

24"

**PG**  
ALU-TECH

**AUSTRIAN**  
ENGINEERING

**Rahmen:** Alu 7005 **Gabel:** Suntour M3020-P24 24" **Schaltung:** Shimano Acera 24-Gang **Kurbel:** Suntour XCCT 102 **Bremsen:** Alu V-Brake **Laufträder:** Naben Alu, Felgen Alu, Reifen Kenda 24 x 1,95  
**Anbauteile:** Lenker Nakita Riser Custom 600mm, Vorbau Nakita Custom, Sattelstütze Nakita Custom  
**Sattel:** Active KIDZ "Nakita Custom" **Rahmenhöhen:** 35cm **Farbe:** black matt/yellow



20"

**KIDZ**  
2.0

**Rahmen:** Alu 7005 **Gabel:** Suntour M3010-P20 20" **Schaltung:** Shimano TX55 14-Gang **Kurbel:** Prowheel **Bremsen:** Alu V-Brake **Laufräder:** Naben Alu, Felgen Alu, Reifen Kenda 20 x 1,95 **Anbauteile:** Lenker Nakita Riser Custom 580mm, Vorbau Nakita Custom, Sattelstütze Nakita Custom **Sattel:** Active KIDZ "Nakita Custom"  
**Rahmenhöhen:** 26cm **Farbe:** green/blue

**PG**  
ALU-TECH

**AUSTRIAN**  
ENGINEERING

**KIDZ**  
**1.0 TEAM****12"**

**Rahmen:** Alu 12" **Gabel:** Alu 12" Prowheel **Bremsen:** Cantilever Brake vorne  
**Laufräder:** Naben Alu, Felgen Alu, Reifen 12" Tubetype **Farbe:** white/red

**KIDZ**  
**1.0 LEMON****12"**

**Rahmen:** Alu 12" **Gabel:** Alu 12" Prowheel **Bremsen:** Cantilever Brake vorne  
**Laufräder:** Naben Alu, Felgen Alu, Reifen 12" Tubetype **Farbe:** green/lemon



NAKITA





# CROSSBIKES

SPORTLICH - ELEGANT - ALLTAGSTAUGLICH

Unsere Crossbike Linie ist aufgrund ihrer hochwertigen Ausstattung der wahre Allrounder und für den Einsatz in Alltag und Freizeit gerüstet. Egal ob eine entspannte Ausfahrt durch die Natur oder eine aufregende Mehrtagestour. Nakita Crossbikes.

Born in the Austrian Alps.

---

# CROSS BIKES

28"



## X-CROSS 7.5 MEN

**Rahmen:** Alu 6061 Double Butted, Monocoque Shape, Postmount Discbrake, integrated Kickstandmount  
**Gabel:** Suntour NCX-D-LO AIR, Remote Lockout, 63mm **Schaltung:** Shimano XT 30-Gang **Kurbel:** Shimano XT **Bremsen:** Shimano M355 Disc **Laufträder:** Naben Shimano, Felgen Alex Rims DP 17 Disc, Reifen Michelin Trans World Sprint 700 x 35 Reflex **Anbauteile:** Lenker Nakita Riser Custom 640mm, Vorbau Nakita Custom, Sattelstütze Nakita Custom **Sattel:** VL-2071 Nakita Custom  
**Rahmenhöhen:** 47, 52, 56, 60cm **Farbe:** black matt/grey





## X-CROSS 7.5 LADY

CROSS  
BIKES  
28"

**DB**  
2X BUTTED  
ALU-TECH

**LADY**  
SPECIFIC  
GEOMETRIE

**PM**  
disc  
mount

**AUSTRIAN**  
ENGINEERING

**Rahmen:** Alu 6061 Double Butted, Monocoque Shape, Postmount Discbrake, integrated Kickstandmount  
**Gabel:** Suntour NCX-D-LO AIR, Remote Lockout, 63mm **Schaltung:** Shimano XT 30-Gang **Kurbel:** Shimano XT  
**Bremsen:** Shimano M355 Disc **Laufträder:** Naben Shimano, Felgen Alex Rims DP 17 Disc, Reifen Michelin Trans World Sprint 700 x 35 Reflex **Anbauteile:** Lenker Nakita Riser Custom 640mm, Vorbau Nakita Custom, Sattelstütze Nakita Custom **Sattel:** VL-4125 Nakita Custom  
**Rahmenhöhen:** 43, 47, 51cm **Farbe:** black matt/grey

# CROSS BIKES

28"



## X-CROSS 5.5 MEN

**Rahmen:** Alu 6061 Double Butted, Monocoque Shape, Postmount Discbrake, integrated Kickstandmount  
**Gabel:** Suntour NEX-HLO, Lockout, 63mm **Schaltung:** Shimano XT 30-Gang **Kurbel:** Shimano T521 **Bremsen:** Tektro HDM-290 Disc **Laufträder:** Naben Alu, Felgen Alex Rims DP 17 Disc, Reifen Michelin Trans World Sprint 700 x 35 Reflex **Anbauteile:** Lenker Nakita Riser Custom 640mm, Vorbau Nakita Custom, Sattelstütze Nakita Custom **Sattel:** VL-2071 Nakita Custom  
**Rahmenhöhen:** 47, 52, 56cm **Farbe:** black matt/blue





## X-CROSS 5.5 LADY

CROSS  
BIKES  
28"

**DB**  
2X BUTTED  
ALU-TECH

**LADY**  
SPECIFIC  
GEOMETRIE

**PM**  
disc  
mount

**AUSTRIAN**  
ENGINEERING

**Rahmen:** Alu 6061 Double Butted, Monocoque Shape, Postmount Discbrake, integrated Kickstandmount  
**Gabel:** Suntour NEX-HLO, Lockout, 63mm **Schaltung:** Shimano XT 30-Gang **Kurbel:** Shimano T521  
**Bremsen:** Tektro HDM-290 Disc **Laufräder:** Naben Alu, Felgen Alex Rims DP 17 Disc, Reifen Michelin Trans World Sprint 700 x 35 Reflex **Anbauteile:** Lenker Nakita Riser Custom 640mm, Vorbau Nakita Custom, Sattelstütze Nakita Custom **Sattel:** VL-4125 Nakita Custom  
**Rahmenhöhen:** 43, 47cm **Farbe:** black matt/blue

# CROSS BIKES

28"



## X-CROSS 3.5 MEN

**Rahmen:** Alu 6061 Double Butted, Monocoque Shape, Postmount Discbrake, integrated Kickstandmount  
**Gabel:** Suntour NEX-HLO, Lockout, 63mm **Schaltung:** Shimano Alivio 27-Gang **Kurbel:** Shimano M311 **Bremsen:** Tektro HDM-290 Disc **Laufträder:** Naben Alu, Felgen Alex Rims DP 17 Disc, Reifen Michelin Trans World Sprint 700 x 35 Reflex **Anbauteile:** Lenker Nakita Custom Riser 640mm, Vorbau Nakita Custom, Sattelstütze Nakita Custom **Sattel:** VL-2071 Nakita Custom  
**Rahmenhöhen:** 47, 52, 56cm **Farbe:** black matt/green





## X-CROSS

### 3.5 LADY

CROSS  
BIKES  
28"

**DB**  
2X BUTTED  
ALU-TECH

**LADY**  
SPECIFIC  
GEOMETRIE

**PM**  
disc  
mount

**AUSTRIAN**  
ENGINEERING

**Rahmen:** Alu 6061 Double Butted, Monocoque Shape, Postmount Discbrake, integrated Kickstandmount  
**Gabel:** Suntour NEX-HLO, Lockout, 63mm **Schaltung:** Shimano Alivio 27-Gang **Kurbel:** Shimano M311  
**Bremsen:** Tektro HDM-290 Disc **Laufräder:** Naben Alu, Felgen Alex Rims DP 17 Disc, Reifen Michelin Trans World Sprint 700 x 35 Reflex **Anbauteile:** Lenker Nakita Custom Riser 640mm, Vorbau Nakita Custom, Sattelstütze Nakita Custom **Sattel:** VL-4125 Nakita Custom  
**Rahmenhöhen:** 43, 47cm **Farbe:** black matt/green

# CROSS BIKES

28"



## X-CROSS 2.0 MEN

**Rahmen:** Alu 7005 **Gabel:** Suntour M3010, 63mm **Schaltung:** Shimano Altus 24-Gang **Kurbel:** Shimano M131 **Bremsen:** Alu V-Brake **Laufträder:** Naben Alu, Felgen Alu, Reifen Kenda 700 x 40  
**Anbauteile:** Lenker Nakita Custom Riser 640mm, Vorbau Nakita Custom, Sattelstütze Nakita Custom  
**Sattel:** Active CROSS "Nakita Custom" **Rahmenhöhen:** 47, 52, 56cm **Farbe:** grey matt/lightning red

**DB**  
2X BUTTED  
ALU-TECH

**A**  
AUSTRIAN  
ENGINEERING





## X-CROSS 2.0 LADY

CROSS  
BIKES  
28"

**DB**  
2X BUTTED  
ALU-TECH

**LADY**  
SPECIFIC  
GEOMETRIE

**A**  
AUSTRIAN  
ENGINEERING

**Rahmen:** Alu 7005 **Gabel:** Suntour M3010, 63mm **Schaltung:** Shimano Altus 24-Gang **Kurbel:** Shimano M131 **Bremsen:** Alu V-Brake **Laufträder:** Naben Alu, Felgen Alu, Reifen Kenda 700 x 40 **Anbauteile:** Lenker Nakita Custom Riser 640mm, Vorbau Nakita Custom, Sattelstütze Nakita Custom **Sattel:** Active CROSS "Nakita Custom" **Rahmenhöhen:** 43, 47cm **Farbe:** grey matt/lightning red

# GEOMETRIE

Modelle	ENGINE C SERIES 27.5			ENGINE ALLOY SERIES 27.5				BLAZE C SERIES 27.5				STINGER C SERIES BIG			STINGER ALLOY SERIES BIG		
	16 Zoll	18 Zoll	20 Zoll	15 Zoll	17 Zoll	19 Zoll	21 Zoll	15 Zoll	17 Zoll	19 Zoll	21 Zoll	16 Zoll	18 Zoll	20 Zoll	16,5 Zoll	18,5 Zoll	20 Zoll
Rahmengröße (Zoll)	16 Zoll	18 Zoll	20 Zoll	15 Zoll	17 Zoll	19 Zoll	21 Zoll	15 Zoll	17 Zoll	19 Zoll	21 Zoll	16 Zoll	18 Zoll	20 Zoll	16,5 Zoll	18,5 Zoll	20 Zoll
A - Sitzrohrlänge (mm)	406	457	508	381	432	483	533	385	432	483	520	406	457	508	420	470	515
B - Oberrohr horizontall (mm)	559	584	610	550	575	590	605	537	567	591	611	550	588	625	570	590	610
C - Oberrohrlänge (mm)	-	-	-	-	-	-	-	-	-	-	-	-	-	-	554	574	593
D - Steuerrohrlänge (mm)	115	120	130	100	100	110	120	105	115	135	155	130	135	150	115	125	135
E - Kettenstrebenlänge (mm)	438	438	438	438	438	438	438	430	430	430	430	440	440	440	440	440	440
F - Radstand (mm)	1133	1158	1183	-	-	-	-	1070	1100	1126	1147	1072	1112	1148	1102	1123	1144
G - Steuerrohrwinkel	67,0°	67,0°	67,0°	67,0°	67,0°	67,0°	67,0°	69,0°	69,0°	69,0°	69,0°	71,0°	71,0°	71,0°	70,0°	70,0°	70,0°
H - Sitzrohrwinkel	73,0°	73,0°	73,0°	73,0°	73,0°	73,0°	73,0°	75,0°	75,0°	75,0°	75,0°	73,5°	73,5°	73,5°	74,0°	74,0°	74,0°

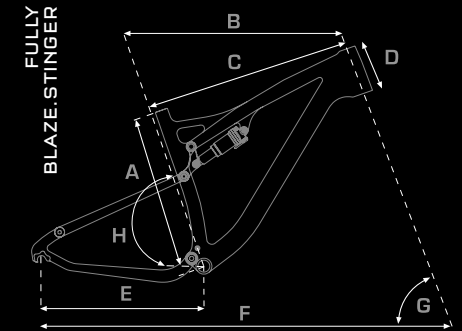
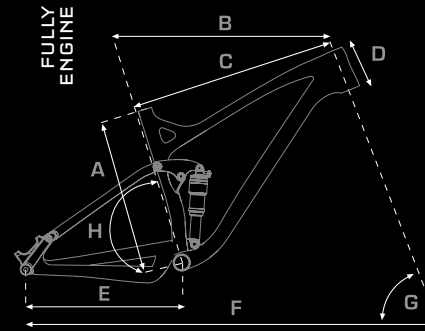

Modelle	TEAM C SERIES BIG 29" PRO, SL, EXPERT, RACE & COMP				EVO SERIES BIG 29" Evo Limited Big			SPIDER SERIES BIG 29" Spider 9.5 Big, 7.5 Big, 5.5 Big				RAM SERIES BIG 29" Ram 5.5 Big, 3.5 Big			TEAM C SERIES 27.5" PRO, SL, EXPERT, RACE & COMP				EVO SERIES 27.5" Evo Limited 27.5				SPIDER SERIES 27.5" Spider 9.5, 7.5, 5.5			
	15 Zoll	17 Zoll	19 Zoll	21 Zoll	17 Zoll	19 Zoll	21 Zoll	17 Zoll	19 Zoll	21 Zoll	22.5 Zoll	17 Zoll	19 Zoll	21 Zoll	15 Zoll	17 Zoll	19 Zoll	21 Zoll	15 Zoll	17 Zoll	19 Zoll	21 Zoll	15 Zoll	17 Zoll	19 Zoll	21 Zoll
Rahmengröße (Zoll)	15 Zoll	17 Zoll	19 Zoll	21 Zoll	17 Zoll	19 Zoll	21 Zoll	17 Zoll	19 Zoll	21 Zoll	22.5 Zoll	17 Zoll	19 Zoll	21 Zoll	15 Zoll	17 Zoll	19 Zoll	21 Zoll	15 Zoll	17 Zoll	19 Zoll	21 Zoll	15 Zoll	17 Zoll	19 Zoll	21 Zoll
A - Sitzrohrlänge (mm)	380	432	483	532	430	480	530	430	480	530	570	430	480	530	381	432	483	533	380	430	480	530	380	430	480	530
B - Oberrohr horizontall (mm)	575	590	610	625	590	615	630	595	615	630	645	595	609	619	565	585	603	613	560	580	600	620	560	585	590	600
C - Oberrohrlänge (mm)	-	-	-	-	570	590	605	573	589	605	623	573	584	595	549	561	577	593	550	560	575	595	547	564	565	575
D - Steuerrohrlänge (mm)	100	110	110	115	110	115	125	110	115	125	130	110	110	115	105	105	125	145	110	120	135	145	115	120	125	130
E - Kettenstrebenlänge (mm)	445	445	445	445	445	445	445	455	455	455	455	455	455	455	430	430	430	430	435	435	435	435	435	435	435	435
F - Radstand (mm)	-	1108	1118	1133	1084	1108	1124	1098	1118	1134	1149	1098	1113	1123	1045	1065	1084	1095	1053	1074	1094	1114	1045	1071	1076	1086
G - Steuerrohrwinkel	70,0°	70,0°	70,0°	70,0°	71,0°	71,0°	71,0°	71,0°	71,0°	71,0°	71,0°	71,0°	71,0°	71,0°	71,0°	71,0°	71,0°	71,0°	70,0°	70,0°	70,0°	70,0°	71,0°	71,0°	71,0°	71,0°
H - Sitzrohrwinkel	73,5°	73,5°	73,5°	73,5°	73,0°	73,0°	73,0°	73,0°	73,0°	73,0°	73,0°	73,0°	73,0°	73,0°	73,0°	73,0°	73,0°	73,0°	73,0°	73,0°	73,0°	73,0°	73,0°	73,0°	73,0°	73,0°

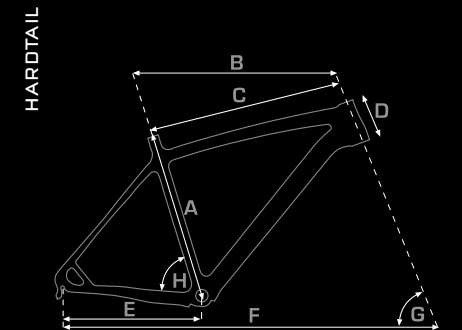

Modelle	RAM SERIES 27.5" Ram 5.5, 3.5, 2.5, 1.5, 1.0				FATBIKE Claw			WILDCAT LADY SERIES 27.5" Wildcat 7.5, 5.5, 3.5, 3.0			CROSSBIKE - Herren X-Cross 7.5, 5.5, 3.5, 2.0				CROSSBIKE - Damen X-Cross 7.5, 5.5, 3.5, 2.0		
	15 Zoll	17 Zoll	19 Zoll	21 Zoll	16 Zoll	18 Zoll	20 Zoll	14 Zoll	16,5 Zoll	18 Zoll	18,5 Zoll	20,5 Zoll	22 Zoll	23,5 Zoll	17,0 Zoll	18,5 Zoll	20 Zoll
Rahmengröße (Zoll)	15 Zoll	17 Zoll	19 Zoll	21 Zoll	16 Zoll	18 Zoll	20 Zoll	14 Zoll	16,5 Zoll	18 Zoll	18,5 Zoll	20,5 Zoll	22 Zoll	23,5 Zoll	17,0 Zoll	18,5 Zoll	20 Zoll
A - Sitzrohrlänge (mm)	380	430	480	530	406	457	508	360	420	460	470	520	560	600	430	470	510
B - Oberrohr horizontall (mm)	560	580	600	620	565	590	625	543	570	585	587	597	612	617	577	587	597
C - Oberrohrlänge (mm)	552	562	577	596	543	564	599	547	556	565	559	571	589	602	612	619	626
D - Steuerrohrlänge (mm)	110	120	135	145	110	120	140	135	140	145	120	140	150	150	150	150	150
E - Kettenstrebenlänge (mm)	435	435	435	435	460	460	460	435	435	435	440	440	440	440	440	440	440
F - Radstand (mm)	1051	1072	1093	1113	1104	1130	1167	1035	1062	1078	1064	1074	1089	1094	1054	1064	1074
G - Steuerrohrwinkel	71,0°	71,0°	71,0°	71,0°	69,0°	69,0°	69,0°	71,0°	71,0°	71,0°	71,0°	71,0°	71,0°	71,0°	71,0°	71,0°	71,0°
H - Sitzrohrwinkel	73,0°	73,0°	73,0°	73,0°	74,0°	74,0°	74,0°	73,5°	73,5°	73,5°	72,0°	72,0°	72,0°	72,0°	72,0°	72,0°	72,0°

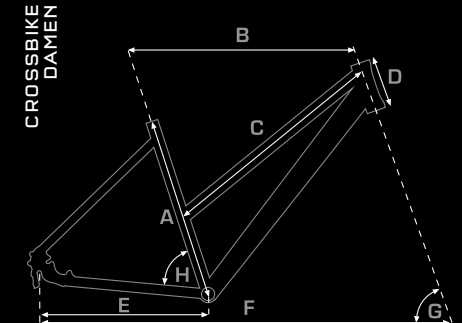
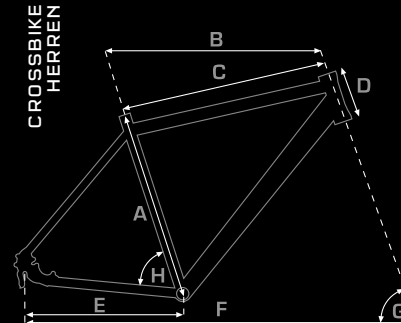

# MODELLÜBERSICHT

	MTB FULLY ENGINE 27,5"							MTB FULLY BLAZE 27,5"				MTB FULLY STINGER 29"				
2015	Engine C PRO	Engine C SL	Engine C EXPERT	Engine C COMP	Engine RACE	Engine EXPERT	Engine COMP	Blaze C PRO	Blaze C EXPERT	Blaze C COMP	E-Blaze COMP	Stinger C PRO	Stinger C EXPERT	Stinger C COMP	Stinger EXPERT	Stinger COMP
Type	ENDURO FULLY 27,5	ENDURO FULLY 27,5	ENDURO FULLY 27,5	ENDURO FULLY 27,5	ENDURO FULLY 27,5	ENDURO FULLY 27,5	ENDURO FULLY 27,5	TRAIL FULLY 27,5	TRAIL FULLY 27,5	TRAIL FULLY 27,5	E-TRAIL FULLY 27,5	CC FULLY 29"	CC FULLY 29"	CC FULLY 29"	CC FULLY 29"	CC FULLY 29"
Rahmen	Carbon UD	Carbon UD	Carbon UD	Carbon UD	Alu M6/6061 T.B	Alu M6/6061 T.B	Alu M6/6061 T.B	Carbon UD	Carbon UD	Carbon UD	Alu M6/6061 T.B	Carbon UD	Carbon UD	Carbon UD	Alu M6/6061 T.B	Alu M6/6061 T.B
Rahmenhöhe (cm)	41, 46, 51	41, 46, 52	41, 46, 51	41, 46, 51	38, 43, 48, 53	38, 43, 48, 53	43, 48, 53	43, 48, 53	43, 48, 53	43, 48, 53	43, 48	41, 46, 51	41, 46, 51	41, 46, 51	42, 47, 51	42, 47, 51
Dämpfer	Fox "Float X CTD BV" 160mm	Rock Shox Monarch Plus, Debon Air, 160mm	Fox "Float CTD BV" 160mm	Rock Shox "Monarch RL" 160mm	Fox "Float X Remote CTD BV" 160mm	Fox "Float CTD BV" 160mm	Rock Shox "Monarch RL" 160mm	Fox "Float CTD BV" 130mm	Fox "Float CTD BV" 130mm	Fox "Float CTD BV" 130mm	Fox "Float CTD BV" 130mm	Fox "Float CTD" 100mm	Fox "Float CTD" 100mm	Manitou Radium Expert, Lockout 100mm	Fox "Float CTD" 100mm	Manitou Radium Expert, Lockout 100mm
Gabel	Fox "F34 Talas Factory CTD", Kashima 160-130mm, 15mm QR	Rock Shox "Pike RCT3", 160-120mm, 15mm QR	Fox "F34 Talas Evolution CTD", 160-130mm, 15mm QR	Rock Shox "Pike RC", 160-120mm, 15mm QR	Fox "36Float" RC2 Fit New Factory 160mm	Fox "F34 Talas Evolution CTD", 160-130mm, 15mm QR	Rock Shox "Pike RC", 160-120mm, 15mm QR	Fox "F32 Float Factory CTD", Kashima, 130mm, 15mm QR	Fox "F32 Float Evolution CTD", 130mm, 15mm QR	Fox "F32 Float Evolution CTD", 130mm, 15mm QR	Fox "F32 Float Evolution CTD", 130mm, 15mm QR	Fox "F32 Float 29 CTD Remote Fit", Kashima 100mm, 15mm QR	Fox "F32 Float 29 CTD Remote", 100mm, 15mm QR	Manitou "Marvel 29 Expert Iso Air Milo", 100mm, 15mm QR	Fox "F32 Float 29 CTD Remote", 100mm, 15mm QR	Manitou "Marvel 29 Comp TS Air Milo", 100mm, 9mm QR
Schaltwerk	Shimano XTR "Shadow Plus" 22-Gang	Sram X0 1x11 Speed	Shimano XT "Shadow Plus" 20-Gang	Shimano XT "Shadow Plus" 20-Gang	Sram X1 1x11 Speed	Shimano XT "Shadow Plus" 20-Gang	Shimano XT "Shadow Plus" 20-Gang	Shimano XTR "Shadow Plus" 22-Gang	Shimano XT "Shadow Plus" 20-Gang	Shimano XT "Shadow Plus" 30-Gang	Shimano XT "Shadow Plus" 10-Gang	Shimano XTR "Shadow Plus" 30-Gang	Shimano XT "Shadow Plus" 30-Gang	Shimano XT "Shadow Plus" 30-Gang	Shimano XT "Shadow Plus" 30-Gang	Shimano XT "Shadow Plus" 30-Gang
Umwerfer	Shimano XTR Direct Mount	E-Thirteen Chainguard	Shimano XT Direct Mount	Shimano SLX Direct Mount	E-Thirteen Chainguard	Shimano XT	Shimano SLX	Shimano XTR Direct Mount	Shimano XT Direct Mount	Shimano Deore Direct Mount	-	Shimano XTR E-Type	Shimano XT E-Type	Shimano SLX E-Type	Shimano XT Direct Mount	Shimano SLX Direct Mount
Schalthebel	Shimano XTR Rapidfire Plus	Sram X0 1x11 Speed	Shimano XT Rapidfire Plus	Shimano SLX Rapidfire Plus	Sram X1 1x11 Speed	Shimano XT Rapidfire Plus	Shimano SLX Rapidfire Plus	Shimano XTR Rapidfire Plus	Shimano XT Rapidfire Plus	Shimano Deore Rapidfire Plus	Shimano XT Rapidfire Plus	Shimano XTR Rapidfire Plus, integrated	Shimano XT Rapidfire Plus, integrated	Shimano SLX Rapidfire Plus, integrated	Shimano XT Rapidfire Plus, integrated	Shimano SLX Rapidfire Plus, integrated
Kurbelgarnitur	Shimano XTR Hollowtech II, 38/26	Race Face Turbine, 32Z.	Shimano XT Hollowtech II, 38/24.	Race Face Turbine Basic 38/24	Race Face Turbine, 32Z.	Shimano XT Hollowtech II, 38/24.	Race Face Turbine Basic 38/24	Shimano XTR Hollowtech II, 38/28	Shimano XT Hollowtech II, 38/24.	Shimano XT Hollowtech II, 40/30/22	Miranda Beta Plus "Custom"	Shimano XTR Hollowtech II, 42/32/24	Shimano XT Hollowtech II, 40/30/22	Shimano SLX Hollowtech II, 40/30/22	Shimano XT Hollowtech II, 40/30/22	Shimano XT Hollowtech II, 40/30/22
Bremsen	Shimano XTR Trail Disc hydraulisch 180/180	Shimano XT Disc hydraulisch 180/180	Shimano XT Disc hydraulisch 180/180	Shimano AMS06 Disc hydraulisch 180/180	Shimano ZEE Disc hydraulisch 203/180	Shimano XT Disc hydraulisch 180/180	Shimano AMS06 Disc hydraulisch 180/180	Shimano XTR Trail Disc hydraulisch 180/180	Shimano XT Disc hydraulisch 180/180	Shimano M506 Disc hydraulisch 180/180	Shimano XT Disc hydraulisch 180/180	Shimano XTR XC Disc hydraulisch 180/160	Shimano XT Disc hydraulisch 180/160	Shimano M615 Disc hydraulisch 180/160	Shimano XT Disc hydraulisch 180/160	Shimano M615 Disc hydraulisch 180/160
Naben/Laufräder	Pancho Wheels Hub's	Pancho Wheels Hub's	Shimano XT Disc QR15/ 142x12	Shimano Deore Disc QR15/ 142x12	Pancho Wheels Hub's	Shimano XT Disc QR15/ 142x12	Shimano Deore Disc QR15/ 142x12	Pancho Wheels Hub's	Shimano XT Disc QR15/ 142x12	Shimano Deore Disc QR15/ 142x12	Shimano XT Disc QR15/ 142x12	-	Shimano XT Disc QR15/ QR9	Shimano Deore Disc QR15/ QR9	Shimano XT Disc QR15/ QR9	Shimano Disc QR9/QR9
Felgen/Laufräder	PW Wheels QR15/142x12	PW Wheels QR15/142x12	Sun Ringle Helix TR27 Custom Disc	Sun Ringle Helix TR27 Custom Disc	PW Wheels QR15/142x12	Sun Ringle Helix TR27 Custom Disc	Sun Ringle Helix TR27 Custom Disc	PW Wheels QR15/142x12	Sun Ringle Helix TR27 Custom Disc	Sun Ringle Helix TR27 Custom Disc	Nakita Custom Disc	Sun Ringle Black Flag PRO QR15/QR9	Sun Ringle Inferno 25 Custom Disc	Sun Ringle Inferno 25 Custom Disc	Sun Ringle Inferno 25 Custom Disc	Sun Ringle Inferno 25 Custom Disc
Reifen	Schwalbe Nobby Nic, 27,5 x 2,25 faltbar	Schwalbe Nobby Nic, 27,5 x 2,25 faltbar	Continental Mountain King, 27,5 x 2,4 faltbar	Continental Mountain King, 27,5 x 2,4 faltbar	Schwalbe Hans Dampf / Rock Razor, 27,5 x 2,35 faltbar	Continental Mountain King, 27,5 x 2,4 faltbar	Continental Mountain King, 27,5 x 2,4 faltbar	Schwalbe Nobby Nic, 27,5 x 2,25 faltbar	Continental Mountain King, 27,5 x 2,4 faltbar	Continental Mountain King, 27,5 x 2,4 faltbar	Schwalbe Rocket Ron, 27,5 x 2,25 faltbar	Continental X-King, 29 x 2,2 faltbar	Continental X-King, 29 x 2,2 faltbar	Continental X-King, 29 x 2,2 faltbar	Continental X-King, 29 x 2,2 faltbar	Continental X-King, 29 x 2,2 faltbar
Lenker	Race Face Next 35, Carbon, 760mm	Race Face Next 35, Carbon, 760mm	Race Face Turbine 35, 760mm	Race Face Turbine 35, 760mm	Race Face Atlas 35, 800mm	Race Face Turbine 35, 760mm	Race Face Turbine 35, 760mm	Easton Haven Carbon 35, 750mm	Easton Haven, 740mm	NAKITA Custom Flat, 700mm	NAKITA Custom Flat, 700mm	FSA Flat SL-K XC-131 OS 685mm	FSA Flat XC-265 OS, 680mm	FSA Flat XC-265 OS, 680mm	FSA Flat XC-265 OS, 680mm	NAKITA Custom Flat, 700mm
Lenkervorbau	Race Face Turbine 35	Race Face Turbine 35	Race Face Turbine Basic 35	Race Face Turbine Basic 35	Race Face Atlas 35	Race Face Turbine Basic 35	Race Face Turbine Basic 35	Easton Haven 35	Easton Haven	NAKITA Custom	NAKITA Custom	FSA SL-K OS-123	FSA OS-168	FSA OS-168	FSA OS-168	NAKITA Custom
Sattel	Fizik Gobi XM "Custom"	Fizik Gobi XM "Custom"	Fizik Gobi XM "Custom"	Selle Italia "X1" Custom	Fizik Gobi XM "Custom"	Fizik Gobi XM "Custom"	Selle Italia "X1" Custom	Fizik Tundra "Custom"	Fizik Tundra "Custom"	Selle Italia "X1" Custom	Selle Italia "Q-BIK" Custom	Selle Italia "X1" Custom	Selle Italia "X1" Custom	Selle Italia "X1" Custom	Selle Italia "X1" Custom	Selle Italia "X1" Custom
Sattelstütze	Rock Shox "Reverb Stealth" 125mm, 31,6mm	Rock Shox "Reverb Stealth" 125mm, 31,6mm	Rock Shox "Reverb Stealth" 125mm, 31,6mm	X-Fusion "Hilo 125" 31,6mm	Rock Shox "Reverb Stealth" 125mm, 30,9mm	Rock Shox "Reverb" 125mm, 30,9mm	X-Fusion "Hilo 125" 30,9mm	X-Fusion "Hilo SL" 31,6mm	X-Fusion "Hilo SL" 31,6mm	Kind Shock "E-Ten Remote" 125mm, 31,6mm	NAKITA Custom	FSA SL-K SP-RK-265, 31,6mm	FSA SP-XC-255, 31,6mm	FSA SP-XC-255, 31,6mm	FSA SP-XC-255, 30,9mm	NAKITA Custom, 30,9mm
Pedale	-	-	-	-	-	-	-	-	-	-	-	-	-	-	-	-
Farbe	carbon matt/stealth	carbon matt/stealth	carbon matt/stealth	carbon matt/lightning red	alloy brushed matt/black	alloy brushed matt/black	black matt/green	carbon matt/stealth	carbon matt/lightning red	carbon matt/lightning red	black matt/lightning red	carbon matt/orange	carbon matt/orange	carbon matt/orange	black matt/white	black matt/white

# MODELLÜBERSICHT

	MTB HARDTAIL 29"														MTB HARDTAIL 27,5"						
2015	Team C PRO D12 BIG	Team C PRO RS1 Big	Team C PRO HILL BIG	Team C PRO BIG	Team C SL BIG	Team C EXPERT BIG	Team C RACE BIG	Team C COMP BIG	Evo LTD. BIG	Spider 9.5 BIG	Spider 7.5 BIG	Spider 5.5 BIG	Ram 5.5 BIG	Ram 3.5 BIG	Team C PRO	Team C SL	Team C EXPERT	Team C RACE	Team C COMP	Evo LTD.	
Type	CC RACE 29"	CC RACE 29"	CC RACE 29"	CC RACE 29"	CC RACE 29"	CC RACE 29"	CC RACE 29"	CC RACE 29"	CC RACE 29"	CC SPORT 29"	CC SPORT 29"	CC SPORT 29"	CC SPORT 29"	CC SPORT 29"	CC RACE 27,5"	CC RACE 27,5"	CC RACE 27,5"	CC RACE 27,5"	CC RACE 27,5"	CC RACE 27,5"	
Rahmen	Carbon UD SL	Carbon UD SL	Carbon UD SL	Carbon UD SL	Carbon UD	Carbon UD	Carbon UD	Carbon UD	Alu 6066 SL	Alu 6061 D.B	Alu 6061 D.B	Alu 6061 D.B	Alu 6061	Alu 6061	Carbon UD SL	Carbon UD	Carbon UD	Carbon UD	Carbon UD	Carbon UD	Alu 6066 SL
Rahmenhöhe (cm)	38, 43, 48	38, 43, 48	38, 43, 48	38, 43, 48	43, 48, 53	43, 48, 53	43, 48, 53	43, 48, 53	43, 48, 53	43, 48, 53	43, 48, 53, 57	43, 48, 53	43, 48, 53	43, 48, 53	43, 48, 53	38, 43, 48, 53	38, 43, 48, 53	38, 43, 48, 53	38, 43, 48, 53	38, 43, 48, 53	38, 43, 48, 53
Dämpfer	-	-	-	-	-	-	-	-	-	-	-	-	-	-	-	-	-	-	-	-	-
Gabel	Fox "F32 Float 29 ICTD Remote Fit", Kashima 100mm, 15mm QR	Rock Shox RS1, Remote, 100mm	Carbon Monocoque SL UD	Fox "F32 Float 29 CTD Remote Fit", Kashima 100mm, 15mm QR	Rock Shox SID RL Remote Lockout, 100mm, 15mm QR	Fox "F32 Float 29 CTD Remote", 100mm, 15mm QR	Rock Shox REBA RL Remote Lockout, 100mm, 15mm QR	Manitou "Marvel 29 LTD. TS Air Milo", 9mm QR	Fox "F32 Float 29 CTD Remote", 100mm, 15mm QR	Rock Shox REBA RL Remote Lockout, 100mm, 15mm QR	Manitou "Marvel 29 LTD. TS Air Milo", 9mm QR	Rock Shox "XC30 TK Solo Air 100mm, Lockout	Suntour "XCM-RL" Remote Lockout, 100mm	Suntour "XCM-HL0" Lockout, 100mm	Fox "F32 Float 27,5 CTD Remote Fit", Kashima 100mm, 15mm QR	Rock Shox SID RL Remote Lockout, 100mm, 15mm QR	Fox "F32 Float 27,5 CTD Remote", 100mm, 15mm QR	Rock Shox REBA RL Remote Lockout, 100mm, 15mm QR	Manitou "Marvel 29 LTD. TS Air Milo", 9mm QR	Fox "F32 Float 27,5 CTD Remote", 100mm, 15mm QR	
Schaltwerk	Shimano XTR D12 "Shadow Plus" 22-Gang	Sram X1 1x11 Speed	Sram X1 1x11 Speed	Shimano XTR "Shadow Plus Direct Mount", 22-Gang	Shimano XT "Shadow Plus" 20-Gang	Shimano XT "Shadow Plus Direct Mount" 30-Gang	Shimano XT "Shadow" Direct Mount" 30-Gang	Shimano XT "Shadow" Direct Mount" 30-Gang	Shimano XT "Shadow Plus Direct Mount" 30-Gang	Shimano XT "Shadow" Direct Mount" 30-Gang	Shimano XT "Shadow" Direct Mount" 30-Gang	Shimano XT "Shadow" Direct Mount" 30-Gang	Shimano XT "Shadow" Direct Mount" 30-Gang	Shimano XT 27-Gang	Shimano XTR "Shadow Plus Direct Mount", 22-Gang	Shimano XT "Shadow Plus" 20-Gang	Shimano XT "Shadow Plus Direct Mount" 30-Gang	Shimano XT "Shadow" Direct Mount" 30-Gang	Shimano XT "Shadow" Direct Mount" 30-Gang	Shimano XT "Shadow" Direct Mount" 30-Gang	Shimano XT "Shadow Plus Direct Mount" 30-Gang
Umwerfer	Shimano XTR D12 Direct Mount	E-Thirteen Chainguard	E-Thirteen Chainguard	Shimano XTR Direct Mount	Shimano XT Direct Mount	Shimano XT Direct Mount	Shimano Deore	Shimano Deore	Shimano XT Direct Mount	Shimano Deore	Shimano Deore	Shimano Deore	Shimano Deore	Shimano Deore	Shimano XTR Direct Mount	Shimano XT Direct Mount	Shimano XT Direct Mount	Shimano Deore	Shimano Deore	Shimano Deore	
Schalthebel	Shimano XTR D12 Rapidfire Plus integrated	Sram X1 1x11 Speed	Sram X1 1x11 Speed	Shimano XTR Rapidfire Plus, integrated	Shimano XT Rapidfire Plus, integrated	Shimano XT Rapidfire Plus, integrated	Shimano Deore Rapidfire Plus, integrated	Shimano Deore Rapidfire Plus, integrated	Shimano XT Rapidfire Plus, integrated	Shimano Deore Rapidfire Plus, integrated	Shimano Deore Rapidfire Plus	Shimano Deore Rapidfire Plus	Shimano Deore Rapidfire Plus	Shimano Deore Rapidfire Plus	Shimano XTR Rapidfire Plus, integrated	Shimano XT Rapidfire Plus, integrated	Shimano XT Rapidfire Plus, integrated	Shimano Deore Rapidfire Plus, integrated	Shimano Deore Rapidfire Plus, integrated	Shimano XT Rapidfire Plus, integrated	
Kurbelgarnitur	Shimano XTR Hollowtech II, 38/28	Race Face "Next SL" 34 Z.	Race Face "Next SL" 34 Z.	Shimano XTR Hollowtech II, 38/28	Shimano XT Hollowtech II, 38/24	Shimano XT Hollowtech II, 40/30/22	Shimano XT Hollowtech II, 40/30/22	Shimano XT Hollowtech II, 40/30/22	Shimano XT Hollowtech II, 40/30/22	Shimano XT Hollowtech II, 40/30/22	Shimano XT Hollowtech II, 40/30/22	Shimano M612 40/30/22	Shimano M523 40/30/22	Shimano FCM-4000 40/30/22	Shimano XTR Hollowtech II, 38/28	Shimano XT Hollowtech II, 38/24	Shimano XT Hollowtech II, 40/30/22	Shimano XT Hollowtech II, 40/30/22	Shimano XT Hollowtech II, 40/30/22	Shimano XT Hollowtech II, 40/30/22	Shimano XT Hollowtech II, 40/30/22
Bremsen	Shimano XTR XC Disc hydraulisch 180/160	Shimano XTR XC Disc hydraulisch 180/160	Shimano XTR XC Disc hydraulisch 180/160	Shimano XTR XC Disc hydraulisch 180/160	Shimano XT Disc hydraulisch 180/160	Shimano XT Disc hydraulisch 180/160	Shimano M506 Disc hydraulisch 180/160	Shimano M355 Disc hydraulisch 180/160	Shimano XT Disc hydraulisch 180/160	Shimano M506 Disc hydraulisch 180/160	Shimano M355 Disc hydraulisch 180/160	Shimano M355 Disc hydraulisch 180/160	Tektro "HDM-290" Disc hydraulisch 180/160	Tektro "HDM-290" Disc hydraulisch 180/160	Shimano XTR XC Disc hydraulisch 180/160	Shimano XT Disc hydraulisch 180/160	Shimano XT Disc hydraulisch 180/160	Shimano M506 Disc hydraulisch 180/160	Shimano M355 Disc hydraulisch 180/160	Shimano XT Disc hydraulisch 180/160	
Naben/Laufräder	-	XO Predictive Steering	-	DT Swiss 350 Disc QR15/ 142x12	DT Swiss 350 Disc QR15/ 142x12	Shimano XT Disc QR15/ 142x12	Shimano Deore Disc QR15/QR9	Shimano Disc QR9/QR9	Shimano XT Disc QR15/ 142x12	Shimano Deore Disc QR15/QR9	Shimano Disc QR9/QR9	Shimano Disc QR9/QR9	Alloy Disc	Alloy Disc	DT Swiss 350 Disc QR15/ 142x12	DT Swiss 350 Disc QR15/ 142x12	Shimano XT Disc QR15/142x12	Shimano Deore Disc QR15/QR9	Shimano Disc QR9/QR9	Shimano Disc QR9/QR9	Shimano XT Disc QR15/ 142x12
Felgen/Laufräder	Reynolds MTN 29" XC, Black Label, Tubeless Ready	ZTR Crest "No Tubes Ready"	Reynolds MTN 29" XC, Black Label, Tubeless Ready	ZTR Crest "No Tubes Ready"	ZTR Crest "No Tubes Ready"	Sun Ringle Helix TR25 Custom Disc	Sun Ringle Helix TR25 Custom Disc	Sun Ringle Inferno 25 Custom Disc	Sun Ringle Helix TR25 Custom Disc	Sun Ringle Inferno 25 Custom Disc	Sun Ringle Inferno 25 Custom Disc	Sun Ringle Inferno 25 Custom Disc	Sun Ringle Inferno 25 Custom Disc	Rims "XCD Disc"	ZTR Crest "No Tubes Ready"	ZTR Crest "No Tubes Ready"	Sun Ringle Helix TR25 Custom Disc	Sun Ringle Inferno 25 Custom Disc	Sun Ringle Inferno 25 Custom Disc	Sun Ringle Helix TR25 Custom Disc	
Reifen	Schwalbe Rocket Ron 29 x 2,25 faltbar	Schwalbe Rocket Ron 29 x 2,25 faltbar	Schwalbe Thunder Burt 29 x 2,10 faltbar	Schwalbe Rocket Ron 29 x 2,25 faltbar	Schwalbe Rocket Ron 29 x 2,25 faltbar	Schwalbe Rocket Ron 29 x 2,25 faltbar	Schwalbe Rocket Ron 29 x 2,25 faltbar	Continental X-King, 29 x 2,2 faltbar	Schwalbe Rocket Ron 29 x 2,25 faltbar	Schwalbe Rocket Ron 29 x 2,25 faltbar	Continental X-King, 29 x 2,2 faltbar	Continental X-King, 29 x 2,2 faltbar	Schwalbe Rapid Rob 29 x 2,25	Impac Ridgepac, 29 x 2,1	Schwalbe Rocket Ron 27,5 x 2,25 faltbar	Schwalbe Rocket Ron 27,5 x 2,25 faltbar	Schwalbe Rocket Ron 27,5 x 2,25 faltbar	Schwalbe Rocket Ron 27,5 x 2,25 faltbar	Continental X-King, 27,5 x 2,2 faltbar	Schwalbe Rocket Ron 27,5 x 2,25 faltbar	
Lenker	FSA Flat SL-K 740mm	Easton EC70, 720mm	Easton EC70, 720mm	Easton EC70, 720mm	Easton EA70, 720mm	NAKITA Custom Flat, 700mm	NAKITA Custom Flat, 700mm	NAKITA Custom Flat, 700mm	NAKITA Custom Flat, 700mm	NAKITA Custom Flat, 700mm	NAKITA Custom Flat, 700mm	NAKITA Custom Flat, 700mm	NAKITA Custom Flat, 700mm	NAKITA Custom Flat, 700mm	Easton EC70, 720mm	Easton EA70, 720mm	NAKITA Custom Flat, 700mm	NAKITA Custom Flat, 700mm	NAKITA Custom Flat, 700mm	NAKITA Custom Flat, 700mm	
Lenkervorbau	FSA SL-K	Easton EC90SL	Easton EC90SL	Easton EC70	Easton EA70	NAKITA Custom	NAKITA Custom	NAKITA Custom	NAKITA Custom	NAKITA Custom	NAKITA Custom	NAKITA Custom	NAKITA Custom	NAKITA Custom	Easton EC70	Easton EA70	NAKITA Custom	NAKITA Custom	NAKITA Custom	NAKITA Custom	
Sattel	Fizik Thar "Custom"	Fizik Thar "Custom"	Fizik Thar "Custom"	Fizik Thar "Custom"	Fizik Thar "Custom"	Selle Italia "X1" Custom	Velo VL-1205 Custom	Velo VL-1205 Custom	Selle Italia "X1" Custom	Velo VL-1205 Custom	Velo VL-1205 Custom	Velo VL-1205 Custom	Velo VL-1205 Custom	Velo VL-1205 Custom	Fizik Tundra "Custom"	Fizik Tundra "Custom"	Selle Italia "X1" Custom	Velo VL-1205 Custom	Velo VL-1205 Custom	Selle Italia "X1" Custom	
Sattelstütze	FSA SL-K, D12	Rock Shox "Reverb Stealth" 125mm, 31,6mm	Easton EC70, 31,6mm	Easton EC70, 31,6mm	Easton EA70, 31,6mm	NAKITA Custom, 31,6mm	NAKITA Custom, 31,6mm	NAKITA Custom, 31,6mm	NAKITA Custom, 31,6mm	NAKITA Custom, 31,6mm	NAKITA Custom, 31,6mm	NAKITA Custom, 31,6mm	NAKITA Custom, 31,6mm	NAKITA Custom, 31,6mm	Easton EC70, 31,6mm	Easton EA70, 31,6mm	NAKITA Custom, 31,6mm	NAKITA Custom, 31,6mm	NAKITA Custom, 31,6mm	NAKITA Custom, 31,6mm	
Pedale	-	-	-	-	-	-	-	-	-	-	VP-992A	VP-992A	VP-992A	VP-992A	-	-	-	-	-	-	
Farbe	carbon matt/ stealth	carbon matt/ stealth	carbon matt/ stealth	carbon matt/ stealth	carbon matt/ lightning red	carbon matt/ lightning red	carbon matt/ green	carbon matt/ green	black matt/ stealth	black matt/white	black matt/white	brushed chrome/ lightning red	grey matt/blue	black matt/ yellow	carbon matt/ stealth	carbon matt/ lightning red	carbon matt/ lightning red	carbon matt/ blue	carbon matt/ blue	black matt / stealth	

# NAKITA

MTB HARDTAIL 27,5"								MTB LADY 27,5"				FAT	CROSS/OFFROAD 28"				MTB KIDZ					
Spider 9.5	Spider 7.5	Spider 5.5	Ram 5.5	Ram 3.5	Ram 2.5	Ram 1.5	Ram 1.0	Wild Cat 7.5	Wild Cat 5.5	Wild Cat 3.5	Wild Cat 3.0	CLAW	X-Cross 7.5	X-Cross 5.5	X-Cross 3.5	X-Cross 2.0 V-Brake	Kidz 3.5	Kidz 3.0	Kidz 2.0	Kidz 1.0	2015	
CC SPORT 27.5"	CC SPORT 27.5"	CC SPORT 27.5"	CC SPORT 27.5"	CC SPORT 27.5"	CC SPORT 27.5"	CC SPORT 27.5"	CC SPORT 27.5"	LADY SPORT 27.5"	LADY SPORT 27.5"	LADY SPORT 27.5"	LADY SPORT 27.5"	FATBIKE 24"	OFFROAD/CROSS 28"	OFFROAD/CROSS 28"	OFFROAD/CROSS 28"	OFFROAD/CROSS 28"	MTB KIDS 24"	MTB KIDS 24"	MTB KIDS 20"	MTB KIDS 12"	Type	
Alu 6061 D.B.	Alu 6061 D.B.	Alu 6061 D.B.	Alu 6061	Alu 6061	Alu 6061	Alu 6061	Alu 6061	Alu 6061 D.B.	Alu 6061 D.B.	Alu 6061 D.B.	Alu 6061 D.B.	Alu 6061 D.B.	Alu 6061	Alu 6061	Alu 6061	Alu 6061	Alu 7005	Alu 7005	Alu 7005	Alu 7005	Rahmen	
38, 43, 48, 53	38, 43, 48, 53	38, 43, 48, 53	38, 43, 48, 53	38, 43, 48, 53	38, 43, 48	38, 43, 48	38, 43, 48	42, 46	36, 42, 46	36, 42, 46	36, 42, 46	43, 48, 53	He: 47, 52, 56, 60 Da: 43, 47, 51	He: 47, 52, 56 Da: 43, 47	He: 47, 52, 56 Da: 43, 47	He: 47, 52, 56 Da: 43, 47	35	35	26	-	Rahmenhöhe (cm)	
-	-	-	-	-	-	-	-	-	-	-	-	-	-	-	-	-	-	-	-	-	-	Dämpfer
Rock Shox REBA RL Remote Lockout, 100mm, 15mm QR	Manitou "Marvel LTD. TS Air Mito", 100mm, 9mm QR	Rock Shox "XC30 TK Solo Air 100mm, Lockout	Suntour "XCM-RL" Remote Lockout, 100mm	Suntour "XCM-HLO" Lockout, 100mm	Suntour "XCT-HLO" Lockout, 100mm	Suntour "M3030", 100mm	Suntour "M3030", 100mm	Rock Shox "XC30 TK Solo Air 100mm, Lockout	Suntour "XCM-HLO" Lockout, 100mm	Suntour "XCT-HLO" Lockout, 100mm	Suntour "M3030", 100mm	Alloy Monocoque SL	Suntour "NCX-D-LO AIR" Remote Lockout	Suntour "NEX-HLO" Lockout	Suntour "NEX-HLO" Lockout	Suntour "SF-M3010"	Suntour "SF13-M3020-P 24"	Suntour "SF13-M3020-P 24"	Suntour "SF13-M3010-P 20"	Alu Starrgabel	Gabel	
Shimano XT "Shadow Direct Mount" 30-Gang	Shimano XT "Shadow Direct Mount" 30-Gang	Shimano XT "Shadow Direct Mount" 30-Gang	Shimano XT "Shadow Direct Mount" 30-Gang	Shimano XT 27-Gang	Shimano Alivio 24-Gang	Shimano Acera 24-Gang	Shimano Acera 24-Gang	Shimano XT "Shadow Direct Mount" 30-Gang	Shimano XT 27-Gang	Shimano Alivio 24-Gang	Shimano Acera 24-Gang	Sram X1 1x11 Speed	Shimano XT 30-Gang	Shimano XT 30-Gang	Shimano Alivio 27-Gang	Shimano Altus 24-Gang	Shimano Acera 24-Gang	Shimano Acera 24-Gang	Shimano TX55 14-Gang	-	Schaltwerk	
Shimano Deore	Shimano Deore	Shimano Deore	Shimano Deore	Shimano FDM-4000	Shimano M190	Shimano M190	Shimano M190	Shimano Deore	Shimano FDM-4000	Shimano M190	Shimano M190	E-Thirteen Chainguard	Shimano Deore	Shimano Deore	Shimano M370	Shimano M131	Shimano TX50	Shimano TX50	Shimano TX50	-	Umwerfer	
Shimano Deore Rapidfire Plus, integrated	Shimano Deore Rapidfire Plus	Shimano Deore Rapidfire Plus	Shimano Deore Rapidfire Plus	Shimano SL-M370 Rapidfire	Shimano SL-M310 Rapidfire	Shimano ST-EF51 EZ Fire	Shimano ST-EF51 EZ Fire	Shimano Deore Rapidfire Plus	Shimano SL-M370 Rapidfire	Shimano SL-M310 Rapidfire	Shimano SL-M310 Rapidfire	Sram X1 1x11 Speed	Shimano XT Rapidfire Plus	Shimano Deore Rapidfire	Shimano SL-M370 Rapidfire	Shimano ST-EF40 EZ FIRE	Shimano SL-M310 Rapidfire	Shimano SL-M310 Rapidfire	Shimano Revoshift	-	Schalthebel	
Shimano XT Hollowtech II, 40/30/22	Shimano XT Hollowtech II, 40/30/22	Shimano M612 40/30/22	Shimano M523 40/30/22	Shimano FCM-4000 40/30/22	Shimano M171 42/34/24	Shimano M131 42/34/24	Shimano M131 44/32/22	Shimano XT Hollowtech II, 40/30/22	Shimano FCM-4000 40/30/22	Shimano M171 42/34/24	Shimano M171 44/32/22	Sram X1, 30Z. "Fatbike"	Shimano XT Hollowtech, 48/36/26	Shimano T521 48/38/28	Shimano M371 48/36/26	Shimano M131 48/38/28	Suntour XCCT 202 42/34/24Z.	Suntour XCCT 202 42/34/24Z.	Prowheel 42/34Z.	-	Kurbelgarnitur	
Shimano M506 Disc hydraulisch 180/160	Shimano M355 Disc hydraulisch 180/160	Shimano M355 Disc hydraulisch 180/160	Tektro "HDM-290" Disc hydraulisch 180/160	Tektro "HDM-290" Disc hydraulisch 180/160	Tektro "HDM-290" Disc hydraulisch 180/160	Shimano M385 Disc mechanisch 160/160	Alu V-Brake	Shimano M355 Disc hydraulisch 180/160	Tektro "HDM-290" Disc hydraulisch 180/160	Tektro "HDM-290" Disc hydraulisch 180/160	Alu V-Brake	Shimano M615 Disc hydraulisch 180/160	Shimano M355 Disc hydraulisch 180/160	Tektro "HDM-290" Disc hydraulisch 180/160	Tektro "HDM-290" Disc hydraulisch 180/160	Alu V-Brake	Hayes MX5 mech. Disc	Alu V-Brake	Alu V-Brake	Cantilever Brake	Bremsen	
Shimano Deore Disc QR9/QR9	Shimano Disc QR9/QR9	Shimano Disc QR9/QR9	Alloy Disc	Alloy Disc	Alloy Disc	Alloy Disc	Alloy	Shimano Disc QR9/QR9	Alloy Disc	Alloy Disc	Alloy	Salsa, Alloy Disc	Shimano Disc Centerlock	KT Alu Disc	KT Alu Disc	Alu	KT Alu Disc	KT Alu	KT Alu	Alu	Naben/Laufräder	
Sun Ringle Inferno 25 Custom Disc	Sun Ringle Inferno 25 Custom Disc	Sun Ringle Inferno 25 Custom Disc	Sun Ringle Inferno 25 Custom Disc	Rims "XCD Disc"	Rims "XCD Disc"	Rims "XCD Disc"	Alu, 36L	Sun Ringle Inferno 25 Custom Disc	Sun Ringle Inferno 25 Custom Disc	Rims "XCD Disc"	Alu, 36L	Salsa Alloy	Alex Rims "DP17 Disc"	Alex Rims "DP17 Disc"	Alex Rims "DP17 Disc"	Alu, 36L	Alu Disc, 36L	Alu, 36L	Alu, 36L	Alu	Felgen/Laufräder	
Schwalbe Rocket Ron 27.5 x 2.25 faltbar	Continental X-King, 27.5 x 2.2 faltbar	Continental X-King, 27.5 x 2.2 faltbar	Schwalbe Rapid Rob 27.5 x 2.25	Schwalbe Rapid Rob 27.5 x 2.25	Schwalbe Rapid Rob 27.5 x 2.25	Schwalbe Rapid Rob 27.5 x 2.25	Schwalbe Rapid Rob 27.5 x 2.25	Continental X-King, 27.5 x 2.2 faltbar	Schwalbe Rapid Rob 27.5 x 2.25	Schwalbe Rapid Rob 27.5 x 2.25	Schwalbe Rapid Rob 27.5 x 2.25	Kenda Juggernaut 26 x 4.0	Michelin Trans World Sprint, 700x35, Reflex	Michelin Trans World Sprint, 700x35, Reflex	Michelin Trans World Sprint, 700x35, Reflex	Kenda 700x40, Reflex	Schwalbe Black Jack 24 x 1.95	Schwalbe Black Jack 24 x 1.95	Schwalbe Black Jack 20 x 1.95	Tubetype MTB 12"	Reifen	
NAKITA Custom Flat, 700mm	NAKITA Custom Flat, 700mm	NAKITA Custom Flat, 700mm	NAKITA Custom Riser, 700mm	NAKITA Custom Riser, 700mm	NAKITA Custom Riser, 700mm	NAKITA Custom Riser, 700mm	NAKITA Custom Riser, 700mm	NAKITA Custom Riser, 640mm	NAKITA Custom Riser, 640mm	NAKITA Custom Riser, 640mm	NAKITA Custom Riser, 640mm	Race Face Turbine 35, 760mm	NAKITA Custom Riser, 640mm	NAKITA Custom Riser, 640mm	NAKITA Custom Riser, 640mm	Zoom "Riser" Alu.	Alu "Riser"	Alu "Riser"	Alu "Riser"	Alu "Riser"	Lenker	
NAKITA Custom	NAKITA Custom	NAKITA Custom	NAKITA Custom	NAKITA Custom	NAKITA Custom	NAKITA Custom	NAKITA Custom	NAKITA Custom	NAKITA Custom	NAKITA Custom	NAKITA Custom	Race Face Turbine 35	NAKITA Custom	NAKITA Custom	NAKITA Custom	Zoom Alu	"Alu"	"Alu"	"Alu"	"Alu"	Lenkervorbau	
Velo VL-1205 Custom	Velo VL-1205 Custom	Velo VL-1205 Custom	Velo VL-1205 Custom	Velo VL-1205 Custom	Velo VL-1205 Custom	Velo VL-1205 Custom	Velo VL-1205 Custom	Velo VL-4125 Custom	Velo VL-4125 "Nakita Custom"	Velo VL-4125 "Nakita Custom"	Velo VL-4125 "Nakita Custom"	Fizik "Tundra" Custom	Velo VL-2071/4125 "Nakita Custom"	Velo VL-2071/4125 "Nakita Custom"	Velo VL-2071/4125 "Nakita Custom"	Active CROSS "Nakita Custom"	Active KIDZ "Nakita Custom"	Active KIDZ "Nakita Custom"	Active KIDZ "Nakita Custom"	Active KIDZ "Nakita Custom"	Sattel	
NAKITA Custom, 31,6mm	NAKITA Custom, 31,6mm	NAKITA Custom, 31,6mm	NAKITA Custom, 31,6mm	NAKITA Custom, 31,6mm	NAKITA Custom, 31,6mm	NAKITA Custom, 31,6mm	NAKITA Custom, 31,6mm	NAKITA Custom, 27,2mm	NAKITA Custom, 27,2mm	NAKITA Custom, 27,2mm	NAKITA Custom, 27,2mm	Rock Shox "Reverb" 125mm, 30,9m	NAKITA Custom, 27,2mm	NAKITA Custom, 27,2mm	NAKITA Custom, 27,2mm	Zoom Alu, 30,4mm	Alu "patent", 30,4mm	Alu "patent", 30,4mm	Alu "patent", 31,8mm	Alu "patent"	Sattelstütze	
-	VP-992A	VP-992A	VP-992A	VP-992A	VP-992A	VP-992A	VP-992A	VP-992A	VP-992A	VP-992A	VP-992A	-	VP-349A	VP-349A	VP-349A	VP-892A	VP-892A	VP-892A	VP-892A	-	Pedale	
black matt/white	black matt/white	brushed chrome /blue	grey matt/ lightning red	black matt/ green	black matt/ yellow	blue glossy/ lightning red	white glossy/ blue	black matt/ white	black matt/ purple	black matt/blue	grey matt/ turquoise	grey matt/ lightning red	black matt/grey	black matt/blue	black matt/petrol	grey matt/ lightning red	grey matt/ blue	black matt/ yellow	green/blue	green/lemon & white/red	Farbe	

# ATHLETEN

## BARBARA MAYER (AUT)

Daten \*24.03.1982 // 179 cm // 61 kg  
Disziplin Mountainbike, Rennrad  
Erfolg 1. Platz Granitmarathon "Xtreme"  
Stärke Powermum



## JAN STÖTTINGER (AUT)

Daten \*21.11.1976 // 174 cm // 68 kg  
Disziplin Mountainbike  
Erfolg 26. Platz Saizkammergut Trophy "Strecke A 211km"  
Stärke Ausdauer, Berg



## ROBERT LOIDL (AUT)

Daten \*05.07.1977 // 174 cm // 69 kg  
Disziplin Rennrad, Mountainbike  
Erfolg 18. Platz Race Across the Alps "RATA"  
Stärke Ehrgeiz, Ausdauer



**SILKE  
SCHRÄTENECKER (AUT)**

Daten \*15.05.1983 // 167cm // 54 kg  
Disziplin Mountainbike, Rennrad, Cyclocross  
Erfolg 2. Platz Dämen Team Transalp 2014  
Stärke Berg



**ANDREAS  
KARNER (AUT)**

Daten \*29.09.1977 // 181 cm // 68.5 kg  
Disziplin Mountainbike  
Erfolg Ö-Meister Cross Country Kategorie Master  
Stärke sehr ergeizig



**YVONNE  
MARZINKE (GER)**

Daten \*15.06.1976 // 162 cm // 55 kg  
Disziplin Para-Cycling Klasse C2, Rennrad, Mountainbike  
Erfolg Bronze Einzelzeitfahren und Straßenrennen UCI Worldcup  
Stärke Einzelzeitfahren



**DANIEL  
TSCHANY (AUT)**

Daten \*28.02.1996 // 178 cm // 66 kg  
Disziplin Rennrad  
Erfolg österr. Nationalteam Junioren Worldcup und EM  
Stärke Allrounder mit Sprintqualitäten

